

Reference Symbol	Symbol Lock	Meaning Definition	Example
.	and	and	$x \cdot y$
$\wedge$	caret / circumflex	and	$x \wedge y$
$\vee$	reversed caret	or	$x \vee y$
+	plus	or	$x + y$
@	ampersand	and	$x @ y$
	vertical line	or	$x   y$
'	single quote	not - negation	$x'$
$\bar{x}$	bar	not - negation	$\bar{x}$
$\neg$	not	not - negation	$\neg x$
!	exclamation mark specific	not - negation	$! x$
$\otimes$	circled plus / oplus	exclusive or - xor	$x \otimes y$
$\sim$	tilde	negation / approximation	$\sim x$
$\Rightarrow$	implies		
$\Leftrightarrow$	equivalent	if and only if	
$\forall$	for all		
$\exists$	there exists		
$\nexists$	there does not exists		
$\Delta$	delta		
$\nabla$	divergence		
$\therefore$	therefore		
$\because$	because / since		
			Pascal C++
$\angle$	vector		
$\equiv$	dimensional stress		
$U \equiv$	universal dimensional stress		
:P	temporal momenta		
			Addendum++

" Klockan skulle gå fortare i rymden, åtminstone om den inte skulle röra sig mycket fort i förhållande till oss. Tiden går verkligen fortare där tyngdkraften (gravitationsfältet) är svagare, så den går fortare på satellithöjd än nere på jorden. Detta är inte ett löst påstående utan ett verkligen uppmätt fenomen, men skillnaden är mycket liten så man måste ha bra klockor för att kunna mäta upp den. Tydligast är det för GPS- systemet, som måste ta hänsyn till att klockorna går fortare ombord på GPS-satelliterna än nere på jorden. Skillnaden är ungefär 38 mikrosekunder (miljondels sekunder) per dag. Det låter inte så mycket, men om man inte korrigerade för detta skulle GPS ge helt tokiga resultat (uppåt en mil fel efter bara en dag utan korrektion). Detta är såvitt jag vet det enda exemplet på "vardagsapparater" som måste ta hänsyn till den allmänna relativitetsteorin för att kunna fungera. "

Anders Eriksson 2011-06-13 Rymd Forum - Translation on page 52 below.

## Addendum For Logistics : Clocking and Gravity -

### CG Commons - Sine Wave Propagation & Logistics Temporal Mechanics

ShwayComs CG-s<sup>4</sup> [www.shwaycoms.com](http://www.shwaycoms.com)

Space binding as matter attracts matter and conformance of the attributes of space within and around. An energy bond binds space with dimensional quality. The bond resulting energy pulls at new space. Space binding refuels the atomic with the presence of continuum as the components are pulled into a depressed orbit from zero point zenith; compressed as a centrifugal plane of acceleration approaches for depth  $\wedge$  expanding as it fleets. This causes a continuum distortion of space between matter by displacement  $\wedge$  propagation hence the gravity bond which hold the stars together in a perfect solid. It is dual pressure of a shrinking  $\wedge$  expanding system. One could say that the bond between planetary bodies is a concept lower pressure of D4 space which is a one dimension meld of perfect solids the basic building blocks of matter CG (Cretina Gemeen<sup>1</sup>). CG  $\wp$  a commons dimension which is immersed in D4  $\wp$  being a mono dimension. Unpolluted space D4 is a perfect solid and is a one-dimensioned element, it has no surfaces superconducting velocity. D4 supports a gradience property and  $\cong$  when separated creating a foundation for distance attribute and dipolarity. The surface of a particle or atom belongs to that element and not also to the space it fills in a perfect solid. One-sided surface used to keep space in which succeeds to keep the mass of space out. In our system like any other we can say that in the past the sun did explode  $\wedge$  we can also say with certainty that it will explode in the future, it is the same event caught in a moment of instance  $t^{-1} \dots t^0 \dots t^1$ . This explosion can be physically experienced at a dimensional time depth of approximately seven and a half minutes in the past from the present  $t^0$ . If we were on the other hand to travel logistically to the future the presence exerted dimensionally by the earth would as quickly dissipate from physical presence leaving greats like Jupiter to do the same fading from the presence of the sun. Time slows down with great dimensional stress as with gravity<sup>2</sup> and this the difference from here to there in space-time allows for what we know to be seconds, minutes, hours and so on. Two perfect solids cannot gel to a single space time; one has to account for separations likewise in SI transition,  $s^2$  presents a distance to D4 at location with co-variance.

An atom has owned depth covariance that is its space. And an atom gives it's space an

---

<sup>1</sup> Akademie voor Nuuze Vlaamsche Tale ( Vlaams van Frans

<sup>2</sup> - Vlaanderen het latin )

Lars Eliasson - 2011 published articles IRF [www.rymdforum.nu](http://www.rymdforum.nu) Rymd Forum Institutet för rymdfysik – Anders Eriksson,

energy surface by in concept spinning around it at the speed of time concocted by it's lowest clock points (complex space-time) of sine " transitions " <sup>3</sup> elementals. Failing this speed results in lost time the origin of decay acceleration which is an energy state.

Space D4 cannot support two-dimensions without collapse ∴ space D4 is one-dimensional. Bonded space is surfaced two dimensional space hence radiated away. A radiated element is an embryonic mass with meta mass ∨ momenta which is lost time ^ also ∴ space-time heat lacks a second dimension it flows between dimensions able to exist in dual dimension creating a backbone for time → gradient ^ dipole from  $s^2$  and yet it is unable to attribute ∠ quality in singular mono dimension for :P. Light seems as traveling in space at velocity does not slow down as it radiates ∴ it forms and collapses at dimensional stress :P without hinder in a common dimension where it is mass less but none the less represents a mass energy from sine. There are forms out there<sup>4</sup>; the energy surface that an atom gives to owned space attributing mass is brought into existence with energy as it is always trying to occupy more space a surface requisite for time ∴ views of an atom are thereby conceptual as an atom is composed of layered surfaces, composed of rings, radiance being a single ring varying in energy thereby structure. An atom occupies many dimensions clashing with the present so we need to examine a single common space-time as occupied by mass ∨ radiance.

---

<sup>3</sup> July / August 2010 - Issue 92 - Infinite energy - Frank Znidarsic - F. 2005. A Reconciliation of Quantum Physics and Special Relativity, General Journal of Physics, December.

<sup>4</sup> <http://www.philosophyprofessor.com/philosophies/platos-theory-of-forms.php>

## Time - Light Speed

Time is a difference of existence and void of existence where speed of radiance can be seen as a measure of a speed of time versus propagation. However this is  $\rightarrow x$  a universal function of seconds, minutes and hours rather a wave's h temporal. Time existence as we know it is essentially a combination of a two-dimensional time dimension. You cannot have a wave in one dimension.<sup>5</sup>

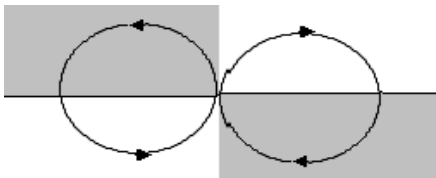
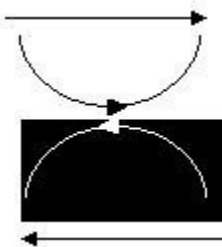

dipole delimiter  
A dipole  
delimiter B  
instance of  
thermal gel  
separation  
membrane  
resonance

Since space-time exists across dimensional planes of acceleration existence, the result is time here as spatial distribution embryonic matter light radiance is between dimensional planes dissected embryonic at conjunction intersects of competing perpendicular centrifugal planes. Light is thereby in a state of inter-existence existing as a wave in resonance on either side of an inertial plane :P h membrane. One of these

---

5

Einstein, A., Lorentz, H. A., Minkowski, H., & Weyl, H. (1952). The Principle of Relativity: a collection of original memoirs on the special and general theory of relativity.

dimensions is common to D4 in nature a mass and existing while the other is  
 →x residing as void with potential to exist.

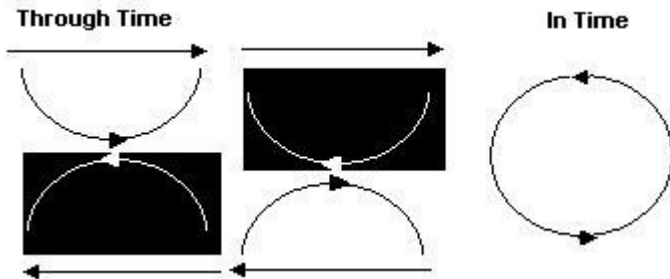

This exhibit of radio shows time (a surface) existing both positively and negatively reflecting two transitioned dimensions of time and how radiance can originate with dipolarity going from D4 physical as electro potential to  $\Phi$  flux via thermal :P membrane store of values at  $s^2$ .<sup>6</sup>

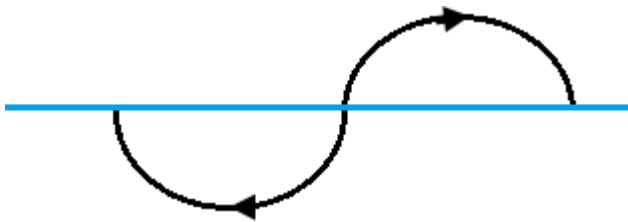

In this illustration one can see light traveling timelessly forward uniting two dimensional planes to a single location flowing in gradient inversely through dimensions; single sin bi-dimensional space-time,  $\therefore$  two  $\vee$  more dimensions are shared to one plane, space-time, Helms inversions<sup>7</sup> take place propagating wave function correlation of angular forces, planes of acceleration,

---

<sup>6</sup>Giovanni Modanese - Large "Dipolar" Vacuum Fluctuations in Quantum Gravity - California Institute for Physics and Astrophysics

<sup>7</sup> Inversion properties shifting push / pull action metric posting relavent physical vis qubit bus value 1/0 - 0/0 - 0/1 fore / aft vis left / right force  $\otimes$  rotation planes as with coriolis plane of acceleration through to inertial force with pull being verbose versus push in minor for inertial rotation polarization's leading edge of planar acceleration metric - Stefan Y. A. Tubman - Rydbergs Johanneberg, Göteborg, Sweden, 2004 Helms reversions. A Helms inversion pinioned by :P dynamic attitude of planes of acceleration in D4 which is an expression of :P energy as gradient from floor  $s^2$  to ceiling expressed for CG-  $s^4$ .

A difference where push ≠ pull

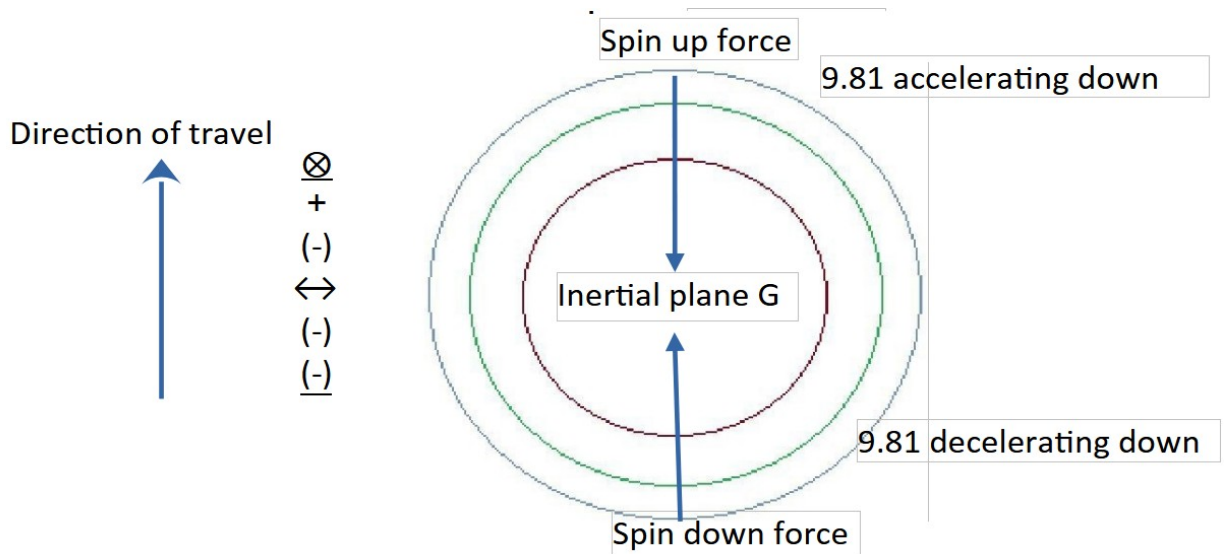

A push is a positive force from vantage heading whereas a pull is of a negative force value from a fore vantage heading reversing as the inertial plane is traversed; pull being verbose relative to direction of travel towards a plane of acceleration  $\wedge$  away. For the upper half of the  $\otimes$  the negative  $x$  followed by a positive  $x'$  produced by inertial plane of acceleration results in  $\otimes$  (1) whereas for the bottom half relative to inertial plane a 2x pull results in  $\rightarrow x$  (0), this being  $fx$  of gravity  $\wedge$  time, immersion in  $U \cong \wedge$  galactic  $\cong \wedge$  local  $\cong \nabla$  D4 two dimensional planes of acceleration; a pinioned attitude heading of dual dimension with up / down integers resulting from plane of acceleration pinion of D4 / CG four  $\angle$  attribute  $\angle \Leftrightarrow :P \wedge$  void proximity divot pinion. The Helmz inversion is foundational in attributing a dipolar property for all dipolars, gradience. Planes of acceleration in D4 are contageous in free space as observed by ISS American astronaut Donald Roy Pettit of Expedition 30/31 with object rotation contagion over span.

Rebind

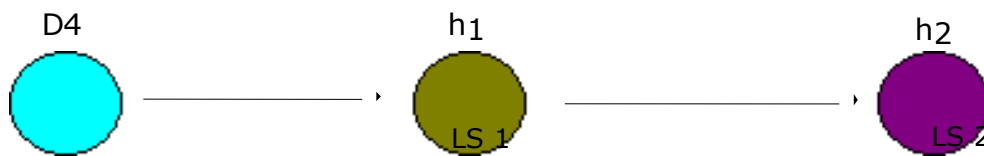

Since void dimensions only exist in a future  $\vee$  past, the present is a reference where matter physical can exist. The future is therefore a void dimension coming into being, the past as inverse where it elapses for a future, event time. Then speed of radiant time becomes then a function of rebind inter dimension precipitated by  $\cong$  at locality for centrifugal planes of acceleration.

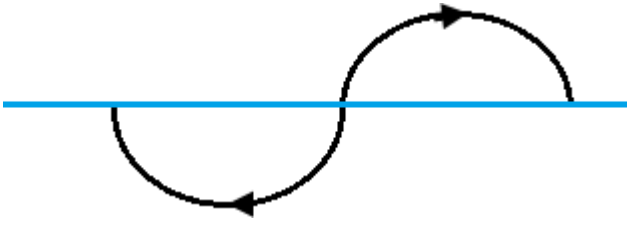

This exhibit shows light / radiance / radio traveling with a speed of time in absence of a void dimension of future. Since it's dimension of future exists within our dimension; the sine is seamless and affords concurrent time with existence of light / radiance within a bandwidth of D4 being itself of CG 'foreign void' given energy.

## Radiance

---

As a rule all radiance originates with a surface reference of  $x^+$  temporal positive in D4 becoming CG with a common reference to dipole membrane attitude of origin  $s^2$ .

---

8

Michio, Kaku (1994). *Hyperspace: A Scientific Odyssey Through Parallel Universes, Time Warps, and the Tenth Dimension*.

## Color

---

Color in the visible range is result of materiel response time in relay of  $\eta$  on time radiance, white light, with reference of a materials covariance and space- time at  $s^2$  to include  $x^-$  for polarity bond of  $s^2$  to h inertial plane.

For radiance long wave forms a property of propagation  $fx$  below time deceleration whereas shorter wave forms have a  $fx$  property of above location time acceleration of a region attributing to  $\cong$  confines of inelastic dimensionality in D4 governing juxtaposition of CG. One has an effective rule for propagates of wave functions with pier velocity of locality  $s^2$  reference C h locality :P.

:P matriculation is functioned at a slower rate respective of locality in short wave function having gravity whereas faster for long wavelengths  $fx$  order thereof which is disparity allowance and consistent velocity C h propagation at given locations having disassociation of non wave function location property  $s^2$  distinct and foreign for velocity of wave form comparative of a natural speed  $t^0$  at location with gauge of propagation and natural constant  $fx$ .

In matriculation of propagation for wave form :P, hours, minutes, seconds, is reduced to a rational consistency where distance available allotment in cycle is  $fx$  exact and finite unit within which propagation is  $fx$ . Attribute of constraint embodying h with C for express of distance to include :P value to allocate requisite distance necessary :P incompressible conveying wave function

completion where  $t^0$  component is a standstill value of  $s^2$   $fx$  for iteration. A finite inelasticity h requisites logic of timeless  $fx$  as common denominator for CG resulting in exclusion  $\otimes$  for correlation of occurrence one another for wave form parse of  $\exists$

## Physical

three dimension particle

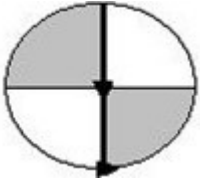

We show a physical existing with complex three physical dimensions as exhibited above  $s^2$  consisting of a dimensional ring in fourth dimension of time which offset one another achieving physical stability and existence by owning space in what can be described as a fourth dimension of time in  $D4^9$  a surface; there are popular arguments like  $R^2D^2$  and also  $D5$  should one consider origin for point. The particle achieves a stability by unifying four dimensions time to a unison space-time which is at a standstill and is present. The present being thereby an accumulation of past and stasis. The future is an accumulation of the present. A particle is essentially the same as light / radiance / radio except that it has been rebound to include a third and thus fourth dimension of present.

9

Hermann Minkowski - Minkowski space -

---

contrasting spatial geometry - Raum und ziet 1909 Leipzig.

Fourth dimension space time

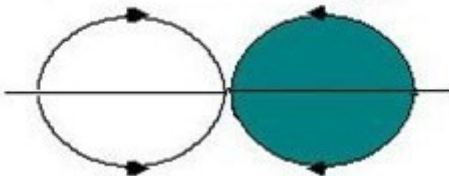

The exhibit above is color coded to show the fourth dimension space sharing of time in white. We experience reality in fourth dimension with other dimensions sharing a common element of existence  $D4$  disassociation of :P

values of attitudinal angular mass. Radiance of a particle evolves from our reality D4 in a fourth dimension and exists in an  $\infty$  infinite reoccurrence of void dimensions separated from the particle by a referenced space-time unified universe. Each permutation of radiance is unique and distinct from previous representations of distinct space-times with includes of changing existence 'temporals'. One can notice a three dimensional particle unifying the space-time differential to a fourth dimension maintaining an absolute space-time in present while contrasting a two dimensional sub element which exists in one element of a fourth dimension. Common to all dimensions for matter existence is a D4 'frame' bind at  $s^2$  with void accelerations of "future" coming into existence deceleration which for a partical is in pivot at rpm velocity having center of mass from  $s^2$  mass center rotational pivot expressing  $90^\circ$  perpendicular centrifugal planes of acceleration sin attitude for SI push and pull having up spin and down spin along with rpm C reference of relative velocities :P mass momenta possessing character of attitude  $90^\circ$  pinion  $s^2$  as  $\exists$  center of mass being a nucleii fulcrum of centrifugal planes of acceleration forces.

## Planar Dimension

In order for a plane<sup>10</sup> to exist three dimensionally as CG, it needs to have exist in four dimensional (ad unknown) complex times for elementals of the fourth dimension through a rebind.

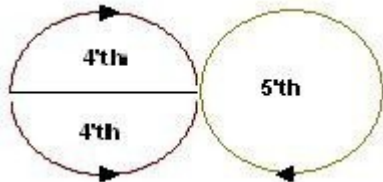

So in the exhibit above, time 'a surface' in the fourth dimension is traveling at all directions unified to a fourth dimension particle. Each half of the fourth dimension physical exists in two dimensions as a fourth dimension seamlessly unifying existence with singularity. That we can see rifts, divisions  $\wedge$  fractions of the fourth dimension is evidenced by materiel radiance. Radiance in fourth dimension is timeless spanning its timeline, bar extraneous influence, timeless with the fourth dimension becoming the present from transits of space-time void dimensional accelerations.

## Common space Ring Component

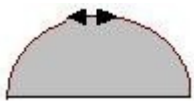

In the exhibit above there are two arrows indicating fluidity  $\theta$ . However this is in the reference of one component of referenced space-time in a fourth dimension, which is timeless the present having momenta; so the arrows are conceptual. Distinct dimensions represent surface with one unit of time in a fourth dimension Planck  $h$  (1) at  $90^\circ$  to  $s^2$  perpendicular. Inside the ring is common space; CG at a conceptual decay from sine. So to say that the two dimensional

---

<sup>10</sup>

ring is made of light  $\nu$  radiance (D4 solid /  $\Phi$  flux waveform) would be accurate. However with it's disposition a ring must be completed with another half of time fraction.

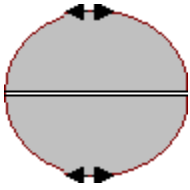

Since arrows are conceptual  $\wedge$  illustrative, we have the following ring in two dimensions supported by base common space mono one  $\wedge$  two to convey  $\angle$  at focal  $s^2$  pivotal for origin attitude of a dipole.

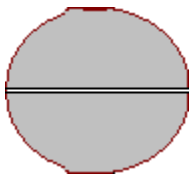

A radiant ring cannot exist in fourth dimension which has three physical dimensions or it would seem to be traveling as radiance inter-existence. Radiance must be rebound in a third incorporating fourth element, time, to make a three dimensional solid with height width and length resulting in the physical of the four compliments of the fourth dimension which recedes into the present away from the future at the iteration speed of time. Binding in third and fourth is event as binding interpolates two mono dimensions  $\angle$  bearing. A conceptual pressure difference a tangent of re-binding in three dimensions unifies a fourth element to a solid space-time where fourth dimension is juxtaposed; a juxtaposition that binds D4 to a static CG frame  $\exists$  above temporal resonance membrane being an  $h$  inertial plane.

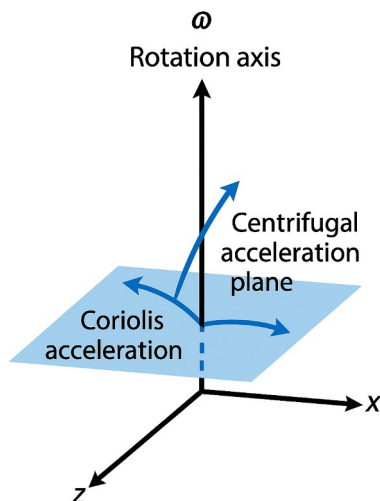

## Rebind

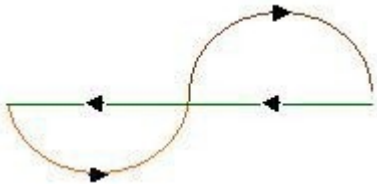

This illustration above shows a rebind. A rebind is an intersection space-time  $90^\circ$  and  $180^\circ$  of a pinioned frame; if you then look at sine, you can see how a fourth dimension unifies to a single D4 space-time as occupied by a particle three dimensionally bar extraneous dimensionality. This is an intersection compiling fourth dimension separately supporting dimensionality which can then support a three dimensional solid versus radiance which is physical and 3! complements having surface space-time of  $t^{-1} \Rightarrow t^0 \Rightarrow t^1$ . Space is twice inverted in two compounding dimensions to stand still physically in time between the future and the past as a :P surface  $t^0$  the present. This is a particle present occupying a single complex space-time CG as a solid distinct from D4<sup>11</sup>.

Centrifugal planar of angular velocities

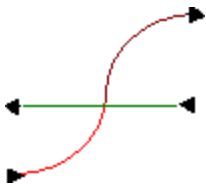

## **Can we logistics travel back in time?**

Not by translocation in the fourth dimension of space-time at any speed as CG and D4 are seamless with singularity and a presence physical must ride. In order to travel back in time one needs to transform a physical state of existence from fourth to a select void dimension, as future, supported by complex dimension with planar velocities which can be seen to exist in the present physically it is possible to propagate to a future as this is an accumulation of the present. What is potentially possible however is to travel instantly in the fourth dimension from one location to another in a timeless reference of time fashion ∵ space is solid and this is exciting! We collapse D4 ahead of the traveler for distance to travel and expand D4 behind the traveler by the distance to traverse alternatively travel in hyperspace. In order to see common space planar rings in the past we must perceive it in fourth dimension at a distance. In order to see it in the future, we have to perceive a void dimension and it can only physically exist in a dimension from which it is perceived with a correct complex space-time composed of CG and infinity of recurring ad hoc void dimensions comprising all matter. Should you achieve to speed up the rate of time in a location you must consider that CG is a physical and timeless and therefore you will only succeed in altering the physical state and presence of elementals in that location see dialogue.

## A sub space effect hyperspace Lorentzian

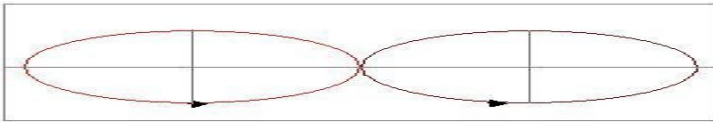

### Lorentzian

Should space-time D4 become distended<sup>12</sup> at unnatural speeds increasing with velocity reduced proximity with void reference chromo-dynamic transition with regard to adjunct

---

<sup>12</sup>

Einstein, A., Lorentz, H. A., Minkowski, H., & Weyl, H. (1952). The Principle of Relativity: a collection of original memoirs on the special and general theory of relativity.

space-time; where 1:00 hour transition in vehicle equates 1:00 + x' hours transitions on earth for  $\angle = \cong a :P$  gradient. The exhibit above shows a conceptual view of this distension to the common space ring element at zero point in the direction of travel. This state of distension is relative to what is adjunct, near space time. A vehicle would by account disassociate with reference to its surroundings ceasing to share D4 in the same physical dimensionality of presence as adjunct D4. However the vehicle remains in D4 with it's zero points pivoting in velocity. Disassociation measurable in the locality becoming an altered state with all traveling within a band of velocity. Ad infinite velocity this is an altered physical dimensional noted in pre emptive relativity to be qualified as increasing in :P hence hyperspace can be described as existing below time  $\cong$  in the past. There is the relationship of time  $\wedge$  acceleration and this is postulated distended by velocity in special relativity; separate phenomena. For centrifugal distension causing local collapse of D4 physicality resulting a hyperspace dissolution effect plausible "quantum chromo-dynamic transition"<sup>13</sup> RGB-V to an asentotic of time where for a vehicle; time propagates faster than in surroundings having reduced proximity to void reference which results from acceleration and expression of velocity by chromo-dynamic transition is a velocity expression  $\rightarrow x$  an argued temporal paradigm as with Lorentzian / special relativity arguments.

A hypothetical hyperspace effect; in hyperspace the vehicle eventually becomes undetectable in D4 dimension  $\wedge$  ceasing interaction with a common dimension at mode of space time. Time is a dimension shared in D4 in different spectrums and this a relationship of distance as an element of time remains valid with void characteristic for velocity replacing an increasing mass argument, a modern concept.

You could say that the time from where you are and four light years away is four years but you have to bear in mind your frame of reference. Your frame of reference is the present and you must also bear in mind that CG is at a complex time with  $\cong$  of which distance is an attribute and in which every space-time is a unique shared location pinioned by  $U \cong$  centrifugal plane of acceleration for attitude pivotal.

Complexities such as the exertion of a systems harmonics are shown determined to slow down time having an effect on the propagating of light and wave forms; speeding up from viewpoint of the observer.

Then there are physics aspects that are as yet undetermined effecting luminal dynamics

such as temperature<sup>14</sup> along with free space subatomic

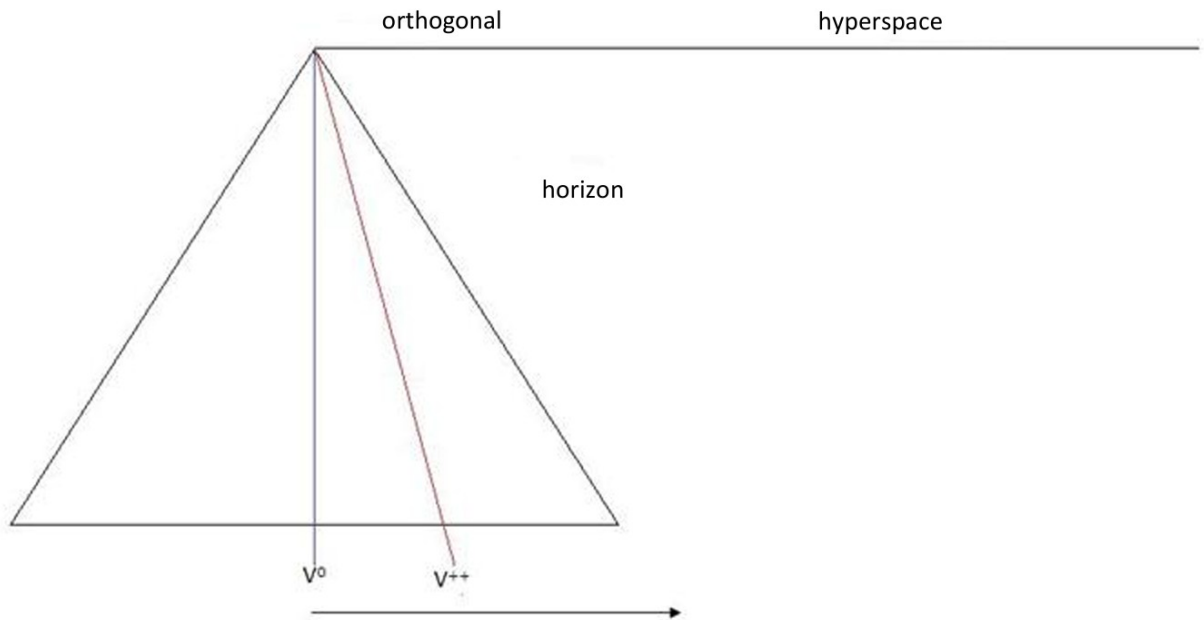

particle saturation<sup>15</sup>. Postulated is that should a body exceed light speed in a unified singularity as our universe it would be as a system at rest in itself where like a black hole with zenith impasse, it would not be visible  $\rightarrow$  present physical as departing  $\vee$  approaching and taking on the property of a contained  $\wedge$  isolated system void.

---

<sup>14</sup>

Lene Hau Vestergaard - Department of Physics, and Division of Engineering and Applied Sciences, Harvard University, Cambridge, Massachusetts 02138, USA

<sup>15</sup> Hawking, Stephen W. (1992). Stephen Hawking's A brief history of time: a reader's companion.

## Dialogue

So if you are in your vehicle time stands still.

No. Time is an invention of constancy to measure the dimension of time D4 at a standstill with a global reference  $h$  being a perpendicular to  $s^2$  which is intersect of D4 above resonant membrane separation. What if you have two clocks in two ships? No. They both arrive at their destinations with a global value reference to time (present)  $t^0$  having both experienced passing of the present at a local iteration. Propagating of physicals in a digital time piece does not reflect a present global value of time due to span, atomic clocks are just that; atomic and mechanical stopwatches difficult to gauge. It is with a notion and opinion that time is a complex inclusive of the biological and mechanical experience change in which would go unnoticed for example to the capillary clock of a plant. Where the present value of time is 2:1 on a vessel, two hours spent on that vessel in deep space equates to an hour spent at ground port seconds, minutes, hours. Low dimensional stress environments increased proximity with referencing dilates time in a location  $v$  causes propagation to the present at an accelerated rate as per sine since temporal presence referencing universal dimensional stress is dilated<sup>16</sup> for example on a planet. Time interpolates as an equinox zenith as with propagation radiance in varied frequency wavelength. With FTL above hyperspace time is suspended to the present reference assuming hyperspace void can be achieved by exceeding light speed however light speed is a reference of velocity  $\rightarrow x$  acceleration. Location variables such as gradient of gravity by proximity to celestials needs to be factored.

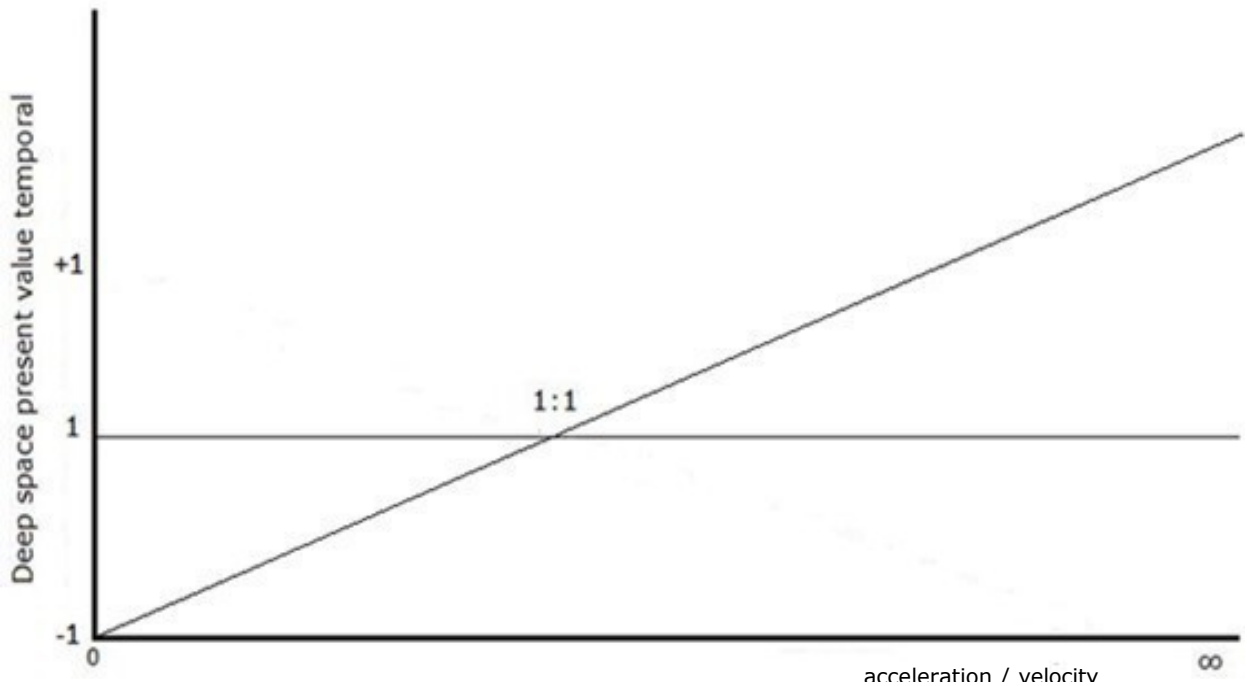

Refer increasing mass with acceleration vs. quantum chromo-dynamic transition .

For instance there are three locations to each it's own temporal we denote as A, B and C. Then take the earth as the middle temporal with location A at a near standstill and C being at a accelerated temporal relative to B. At Location B one has three clocks running at rate of each body, all three locations are present. Then send a vehicle to location A which in turn returns back to C and back again to be relayed to B. There is no opportunity for the vehicle to lapse the initial boarding prior to its departure observing concurrent presence. Communications via instant messaging however can become corrupt and compromised with multiple instant messages being sent through cohesive messaging to the various ports. Decoherence is functioned by sending a message to a different temporal which is relayed to alter local :P and replying messaging becomes decoherent.

In hyperspace conceivably a vessel can achieve a value of depth related presence relating an attitude velocity with D4 in reference a metaphysical reference parameter existing at dimensional space time which cannot index an integral with universal temporal of h baud iteration constraint. This physical is characterized metaphysical with view that an ethereal matter property is imbued with time depth and presence above the  $s^2$  field presented for which increasing  $v$  decreasing proximity of void with another body is a tangent divergence with  $\Leftrightarrow$  result due to commonality reference  $\wedge$  of expressed chromo-dynamic transitioning of a defined equinox at CG planar for a body in confines of a curved space and vessel's presence; alternate planars becoming attractive maintaining fluidity  $\theta$ . Acceleration  $\rightarrow x$  temporal value associate where associated velocity in free space  $\rightarrow x$   $\theta$  fluidity. :P confines in a gravity well depend on attitude with system wide center of gravity well. A verified effect of velocity respective of a gravity well's attitude versus accelerations remains to be observed.

## Comment

The seemingly unsolvable dilemma of distance determination using clocks is now conceivably within grasp by use of time stamped flat visuals from known points having velocity of imaging and a time stamped flat file visuals of points midway in deep space with known point flat charts for interpretation by geometry metrology telemetry reflecting dimensional stress delta  $\nabla$  assertion requisite for transportation authority. An often sited folding of space as one would a piece of paper bringing two points closer paradox illustration by numerous speakers at many podiums. This in order to ascertain consistent relief of distance traveled interstellar.

## Dialogue

So it is impossible to exceed the speed of light as nothing known exceeds this speed.

No; an explosion travels at the speed of light in the bodied dimension; should one capture such an explosion of material and reverse expel it at instance speed; being matter  $\wedge$  logical and  $fx$  of mechanics that one can obtain twice light speed in  $fx$ . Kinetic energy +/- difference is functioned by timely decay as resistance to pry owned space at any speed of competition in common space<sup>17</sup>. There are numerous states of energy complex  $\wedge$  matter complex.

## MV<sup>e</sup> - Mass Velocity Energy

Anomalous weight reduction on a gyroscopes right rotations around the vertical axis on the earth - Department of radiation engineering, Tohoku University, Sendai 980, Japan August 1989.

An infinite mass argument of velocity turns on itself as paradox<sup>18</sup> argument since accelerating any mass past the speed of light with an accelerant which is limited to the speed of light becomes infinite to accelerate at that  $\Leftrightarrow$  barrier. Relativistic observation catalogs increasing mass ambiguous with velocity and can be better expressed as increasing presence with velocity difference  $V$  is integral to difference  $\Delta P$  where  $\Delta P$  denotes temporal presence,  $\theta$ , which takes into account dimensional stress  $\cong$  variance at locality validating a geo space-time temporal value for gravity well attitude and acceleration. A corruption of increasing mass versus increasing momenta at  $h$  inertial plane.

$$V^{\text{integer}} = \sqrt{\frac{t}{s^2 \text{ 12:00 (9.81)}}} \neq V^0 \sqrt{\frac{t}{s^2 \text{ 12:00 (9.81)}}}$$

A resulting observation includes velocity as subset of relativistic mass calculations unspecified  $\wedge$  ambiguous for super luminal  $-s^4$  in void.

---

18

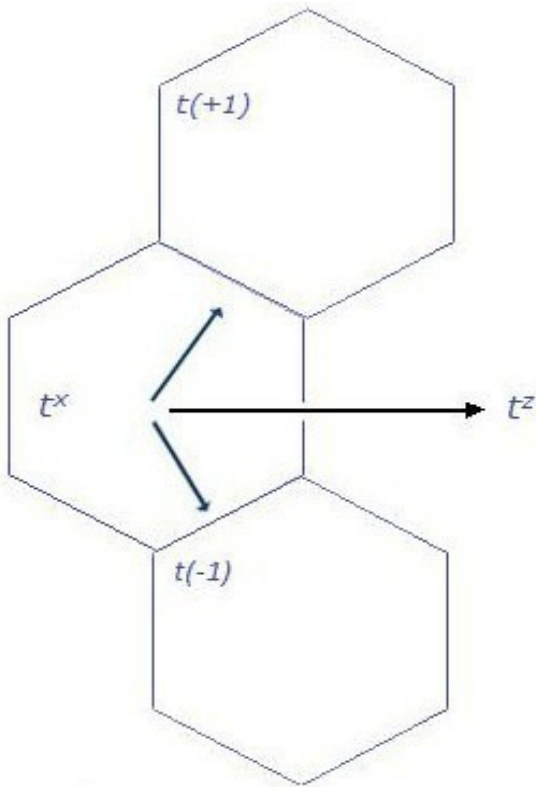

$\Delta s^2 (\Delta s\sqrt{v}) = \cong$  where  $\cong$  is collective spatial resonance expression at  $90^\circ$  of  $h$  in this illustration propagation  $x..z$  versus velocity.

### Hypothetical

---

In a curved space like location planet earth gravity well, gravitational pressure, more specifically it's product kinetic energy is exerted convexly reflecting the spherical planet nature inherently and equatorial orthogonal inertial planes. This when applied geometrically to traversing at given velocity in our system the record has to take in account this fact as one token argumentation perspective contrasting relativistic mass observations. Geometric occupancy change of a spherical  $\nabla$  uniform body traversing in this space one can note faces the following confines.

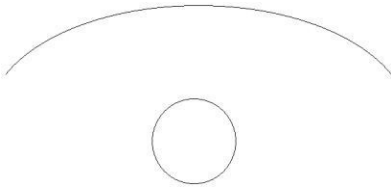

Kinetic velocity / energy in any direction in a gravity well, including towards gravity well mass center under spherical constraints geometrically attempts to occupy a volume of space as defined by curved gravitational constancy is  $\rightarrow$  equal to and in fact less than the space which it previously occupied as gravity is energy exerted space by displacement force hence there is greater space available closer to a celestial resulting in a kinetic dynamic possibly leading to a false conclusion that the mass of object is subset of velocity and  $fx$  thereof rather it's momentum. In fine print this would also require consideration of elevation attitude of the traveling object at  $90^\circ$  perpendicular of center of mass and possibly requisite control of observation. Bearing on this topic, a neutral mass transitioning matter state at any location for space-time mechanics with regard to relational speed of time one concludes is a fluid matter state sharing a centrifugal plane reference where  $\otimes$  of  $\# s^2$  devaluation paired  $\cong$  of sine inertial horizon  $\wedge$  either side of that solid state is a  $\cong$  of space-time local  $h$  for CG. Energy being a collective of  $\cong$  occupying a transitioned dimensional plane at  $t^+$  excess of CG aggregated constant and consequently exhibiting a distinct stable clock dimension at  $s^2$  correlates with energy common in regard to time iteration, fluid  $\wedge$  concurrent CG / D4 difference of  $\cup \exists$  present; concluding confines of a mass in motion  $s^2$  embodies as origin D4 being above planar resonance:

$$s^2 (\sin \leq \cos) \wedge s^2 (\cos \leq \sin) = M_0$$

A logical argument where in practice a difference of veer, plane of acceleration, is noted in transition, this said, collider research does not apparently focus on kinetic dynamics for the time being. To curve space requires a definition of the global space from a point and thereby a curved space becomes a curvature of the defined space by lateral graviton expression of  $h$  for expression of greatest SI occupancy. In a closed system with reference from prime star, space references curved, referencing planets at a common dimension of time, it curves locally for celestials giving locations temporal values integral to space-time at a function of gravity for an inertial plane. A curved space for the universe being a reference to a CG planar cosine for which expansion can take place created by singularity at a boundary  $t^{-1} \Rightarrow t^0$  of creation  $\Rightarrow$  equating  $\exists$  in moment of a physical constant  $h$  mass inertial plane  $\exists$  is a surface.

## Speed of time in D4

Time is expanding and contracting in a  $\angle$  dimension; the future being a reversal at rate of the past regarding the present for radiance where the unit yardstick is represented in an overlap of past and future resulting from a velocity with regard to the space-time dimension. With reference to the future all existence is physically in the past and reverse for the past existing with the two being void of one another similar of a natural state. You can calculate a speed of time in resolution, 2D default of gain, using distance, attribute of  $h \rightarrow x$  a global temporal function of seconds, minutes and hours evidence dilation sine acceleration deceleration. In view of this we can say that the time depth of a system is determined by the mass center of the system in question. Time for CG is a field at impasse zenith horizon and standstill  $h$  inertial plane a surface with area  $s^3$  and it has no iteration  $\therefore$  a dimension is a merge of  $360^\circ$  momentum values as shared  $\nabla$ . An abject global where matter presents complex space-time therefore greatest space collectively in excess of D4 volumetric with less presence of space-time D4 at temporal in  $\Sigma$  total for volume SI. In comparison D4 dimension sharing becomes geld of perfect solids, a coin. Energy is a property of radiance depriving indexed reference in D4 requiring momenta external to attain volume SI; exhibit dilation gravitation and rectify / formatting<sup>19</sup>  $s^2$  a space time. Velocity is polarization different from flux of gravity well  $\wedge$  postulated to equate acceleration for a temporal value.

Radiance dynamic correlates  $t^{-1} \dots t^0$  with value  $x^+$  in index of signature.

We have :P geo for an assigned value  $fx$  7,5 minutes where :P  $\nabla$  is  $x^- \Delta x^+ / AU$  for gravity at location with includes local variable mass of geo-lunar a subsystem  $fx$   $s^2$  in a rotation pivoting focal.

In absence of time a wave form presents a torus composite of immiscible nature that physically exists in lapse of plural  $\Leftrightarrow$  distinct dimensions attaining void status with an abject :P; where two dimensions share a location being distinct from origin, alter dimensions, perfect solids at velocities  $\exists$  respective one another to support centrifugal plane  $\angle h \Rightarrow t^0$

---

referencing each other results in a  $\cong$  distinction that  $\exists$  as momenta  $\rightarrow$  physically  $\exists$  in either having no reference of  $\angle$  quality; indexed as space time  $\exists$  in a separated spatial resulting in maintenance of a physical presence to propel wave forms with reference to adjunct space-times. Propagation is a difference of that which is distinct from the wave forms gravity signature posing furthest possible horizon body potential for migration and consumption. For wave forms space-time where on adding time separation with a gradient from  $s^2$  a location is collided to an occupied point in a mono dimension existing  $\rightarrow$  present in two locations. Thereby with respect to being either a dimension in  $\Phi$  frame  $\vee$  a frame of D4 a planar void value for a torus is  $\otimes$  logical of both points origin with an indexed void plane by wave function defining its space-time value as separated from a distinct dimension's gravity signature, it's anti-verse; an exclusion shadow, which shows with a logic for a torus wave form. A resulting wave form encompasses a static field of body of static  $\angle$  at  $\theta$  referencing a  $s^2$  plane of an electro- $\Phi$  dipole where there are evolving differences of potential distance since a CG space-time is a shared one. Dynamics result from time existence of a surface  $h$  with potential values at a planar space-time difference in a direction potential of  $\angle$  coinciding that it's opposite forms share configuration index arrangement with static fields where  $\Phi$  potential is a gradient arrangement of potentials resulting in a geometric curvature. For a universal body, distinct dimension, an occupied space-time, a surface, lowers the potential for migration for other global locations considering that potential to migrate to a previously occupied location is mitigated by  $\otimes$  logical up / down since rate of change for a system stellar singularity is zero above  $U \cong$ . An electro  $\Phi$  dipole's propagation becomes then a natural velocity being a cosmologic expression of  $\cong$  dilation when origin  $\angle$  impose value completion for maintenance of distance potential in an electro- $\Phi$ 's plane indexed with  $s^2 \nabla$  from dimension void solids and having time  $\exists$  in origin; dimensions  $\exists$  with distinct planar values,  $h$  inertial centrifugal plane energies at  $90^\circ$  that are referenced in relativity with cosmologic constants  $C$  and noted e.g. Mach's Principle.

A D4 volume reflects a value potential of  $\cup$  infinity where for example center celestial centrifugal plane of acceleration with a defined spatial referencing a D4 location for velocity to include a variable of change at zero  $\rightarrow x$  foreign dynamic with spatial attribute of a distance for rotation. For a distinct dimension spatial volumetric comprising a distinct volumetric it follows that location at coexist ceases to be singular to express  $\theta$  to include migrating reference by necessitating expression of plural values for location thereby variables of location qualify for a changing space-time attributes resulting that a location can express gain in volume with  $x^-$  value of a void foreign to D4 refer:  $\theta$  for  $\cong$  from pivotal pinion reference

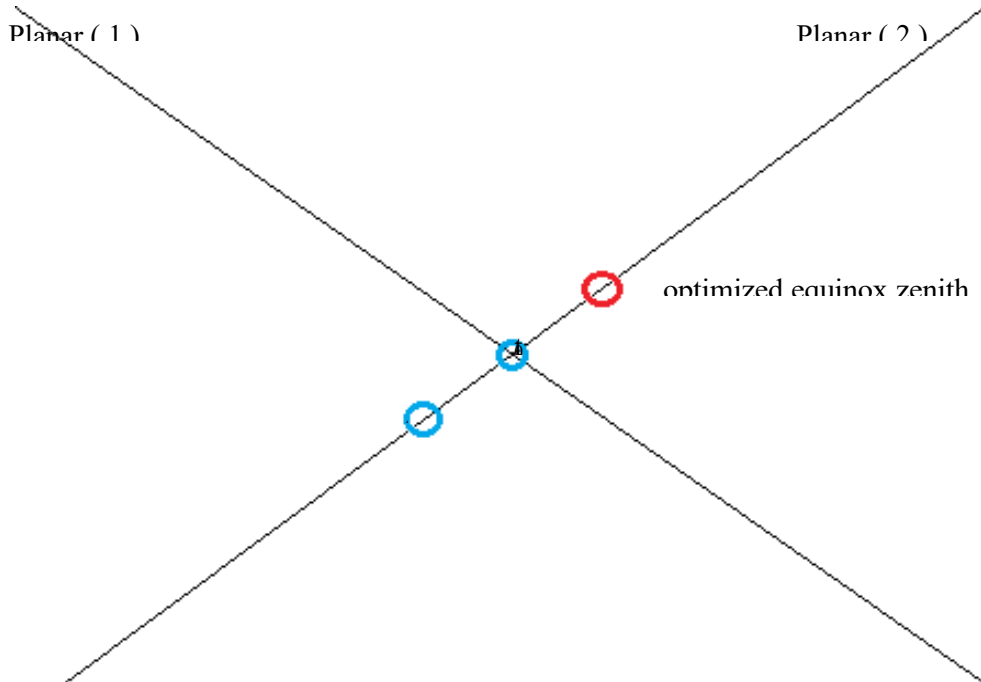

Illustrated is planar mono dimension represented with a straight line supporting a single value distance of two points indexed by a dimensional  $s^2 \cong$  in  $D4$  of universal distinct from a complex planar value of CG being referenced by a plural of voids. Shown here as a distinct dimension functional for electro- $\Phi$  which is time surface value of a distance away from null, resulting co-location where progression  $t^{-1} \dots t^0$  presents an optimized equinox zenith over time  $t^{-} \Rightarrow t^0 \Rightarrow t^{+}$  of universal  $\cong$  of  $h$  inertial plane where  $t^0 \nexists$  as :P mass; it's zero field planar inertial reference to space-time  $D4$  changes along with potential of expressed distances which is a  $\cong$  of an evolving optimized equinox zenith where  $\cong$  is relieved by propagation away from an indexed gravity signature, presenting a prize of potential in a void for any  $\otimes$  potential to surface as electro  $\Phi$  dipole dimensional factoring any velocity other than origin of this signature. An evolving index of time as with  $t^{-1} \dots t^0$  - dynamics of radii in CG by a mono complex dimension such as electro- $\Phi$  radiance requiring time surface to be unified as singular in a plural of voids where rate of change does not realize  $\angle$  of values exhibited by  $\otimes$  of a singular value in  $D4$ ; a distance, resolution equated with force such as a pressure absent of attitude and origin quality  $\angle$  a  $\Phi$  compensating for occupancy  $U \cong t^0 \dots t^1$  for which  $t^1$  becomes a void static location. An observation for which energy is superfluous to  $\otimes$  by gain of void potential is where long wave forms are consumed with low energy yield when radio attains equinox of dynamic  $h$  a location presenting  $\vee$  at planar reference existing as a surface and a consumable separated by time-distance potential  $\cong$  being time  $\cong$  altering a wave packet  $\rightarrow x$  occurrence in permutation being result of  $\cong$ .

## Perspective

planar of positive reference

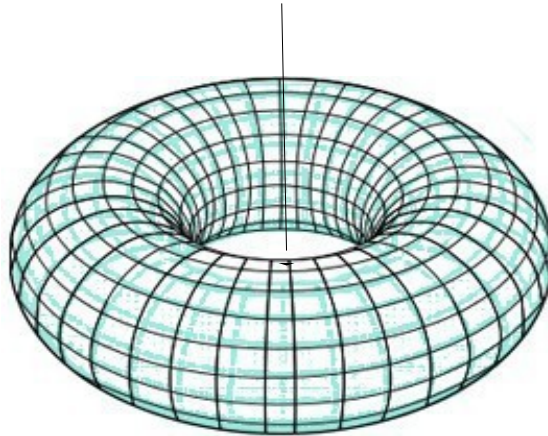

$s^2$

negative reference - planar floor D4

This illustration shows a torus with a gradient reference of  $\#$  that is above  $s^2$ . The torus is inter existence existing above  $s^2$  which requisites a store of values to reflect values of a shape, a dimensional, including planar positive and negative references alter dimensional while exhibiting also gravity of mass at  $s^2$ . It is a torus  $\#$  with reference location of a void at  $s^2$  concurrently propagating in  $\theta$  for a light cone in free space. CG planar from  $s^2$  cannot consume a void reference without physical rendering also propagation at a velocity is an index of :P rather than an acceleration  $\nabla$  as with  $\cong$  for example parachuted falls such that acceleration is matched by coefficient drag  $\otimes \cong$ . Least distance route factor cannot be rendered with linear  $\rightarrow x \theta$  a consequent result of h constraint for  $\exists$  to a location  $\#$  @  $s^2$  with  $\otimes$  resulting propagation at velocity for finite value in  $fx$  t momenta for which propagation resolves  $\cong$  where  $t^{-1} \dots t^0$  for location above  $s^2$ . Plane of positive reference can in this way exhibit a body shape with store of values for  $\Sigma$  of stored values with include of an external

velocity value; a juxtaposition of distinct void dimensions immiscible  $\wedge$  abstract to render  $\cong$  spin directional centrifugal forces. Void dimension distinct of  $s^2$  as  $s^2$  in mate of D4 presenting potential with gravity signature index at  $s^2 - h$  a requisite in  $\otimes$  radii. Plane of positive reference is this forms surface with a requisite radial minimum of a Planck unit ( $r \geq h$ ) referencing planar floor void in focal absent for radiance  $s^2 \cong \text{null}^{20}$  h requisite in  $fx \cong$  a store of consumed potentials by void singularity torus.

Seen here an electro  $\Phi$ 's form showing a singularity sharing location at h

inertial plane in positive reference which is it's complex space-time and coordinate unique complex as point is a reference to  $\exists \cdot \#$  with include  $\cong \neg$  represented for velocity propagation being an external value,  $s^4$ , multiple clock points  $t^{-1} \dots t^0$ . Seen in this way a  $\otimes$  at mass center positive plane space-time gels with fictitious quality  $x'$  since a torus both gels  $\wedge \#$  reflecting gradient with a void  $\Leftrightarrow x \dots y$  present  $s^2$   $s\sqrt{\quad}$  signature is  $s^2$  index adjunct thermal SI immiscible with D4  $\exists$  as gel above  $s^2$ .

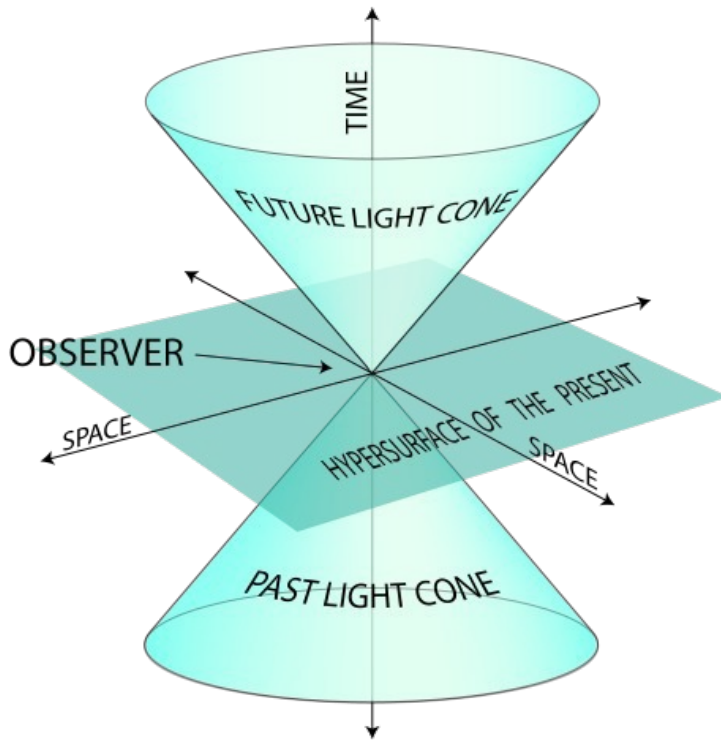

Dipole time at  $s^2 \wedge \theta \cong$

One dimensioned perfect solid without surfaces it is it's own zero point requisite of a singularity system stellar.

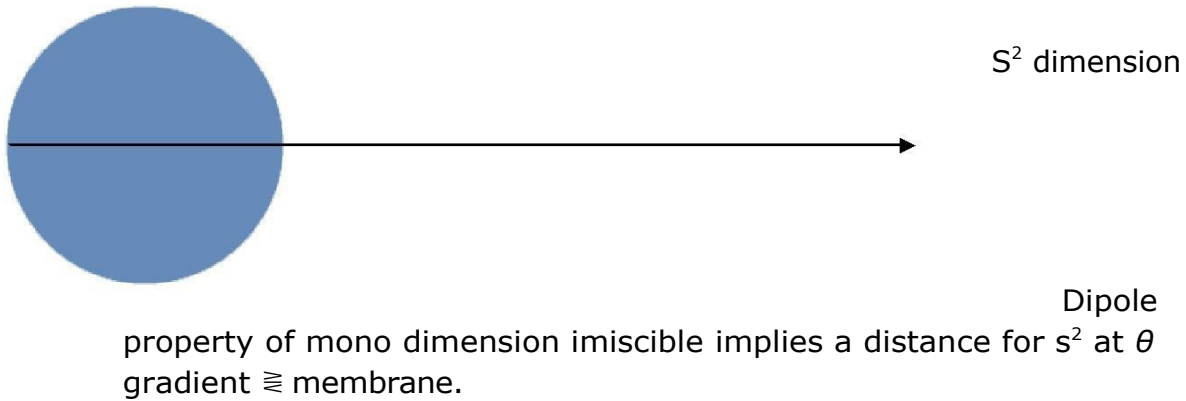

As it is not possible to represent distinct points without distance one implies different dimensions unless a point in question is absolute center of a dimension; from the configuration of the dipole field above we see space defining a point that is inverted going from positive to negative.

With universe expansion or D4 contraction  $U \cong$ , distinct dimensions of the universe are at their own velocities also distinct of each other with regard to the common dimension in which the universe sits depending on fixed point SI distribution; velocity h inertial plane being momenta and particle above  $s^2$  an event persisting and is present in continuum.

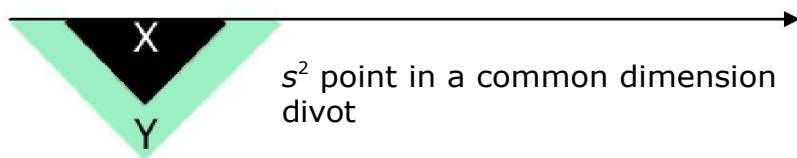

Reflecting a point takes on a order of magnitude as noted with  $s^2$  since the origin distances of dipole end positive and negative represent  $\angle$  of velocities referencing one another.

One can take a look at a wave which exists has time  $\wedge$  can present itself in a one dimension in conjunction of  $t^{-1} \dots t^0$ .



representing

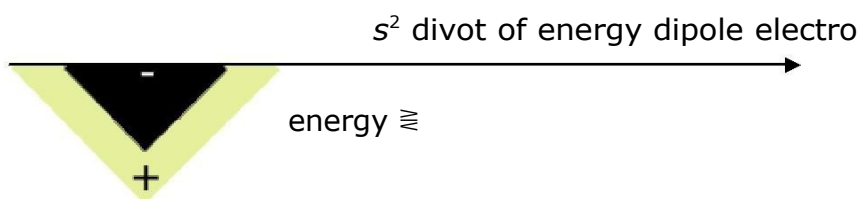
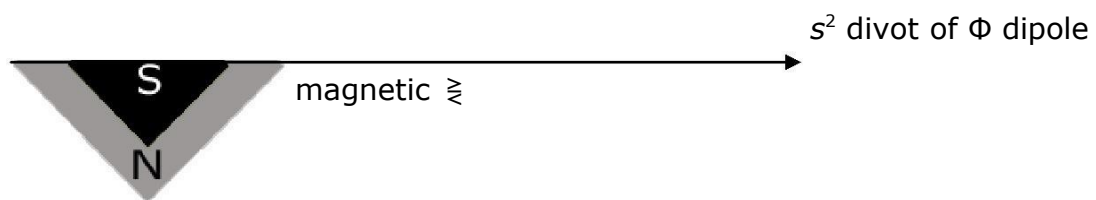

We notice four values in distinct dipole divot presence dimensions that can each express a difference of two values. A difference of two points  $x, y$  in the common dimension representing four distinct values can do so reflecting three commonality values at any one point along a dipole with a spatial difference that cannot exist a void foreign surface referenced as distance from  $s^2$ , presence of a form with time dimension a surface separation 3! completing dipole divot at a distance from  $s^2 \forall$  null and unique located at  $N+$  for  $t^- D4 \forall fx$  distinct voids<sup>21</sup>  $\cong$ .

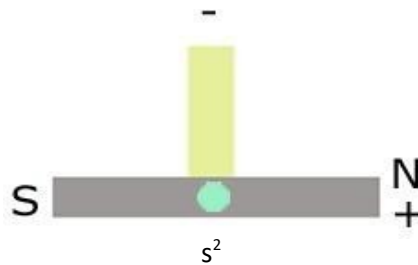

A fourth point (-) in this configuration shown  $\rightarrow x$  exists with a corresponding dimension and is a momentum of origin dimension location  $s^2$  and is a void reference for location.

In order to complete at three points in one dimension of a dipole, two paths of connect are necessary. One of the two paths needs to intersect and go around the other and in so doing, requiring acceleration for momenta; a monopole cannot show acceleration without gradient acceleration a distance  $x' \forall x' + 1$  where we now have two distance points at a mono dimension location. Connecting three points in a mono dimension results in  $\cong$ , resulting in potential of momentum from suppression of a velocity momenta, all possible points a two point transition of null in mono dimension of a dipole are connectable at any level physically having different connect potentials with values.

---

21

1. Void singular absolute  $\theta$  where  $\cong$  is null singularity as with closed loop torus  $s^2$

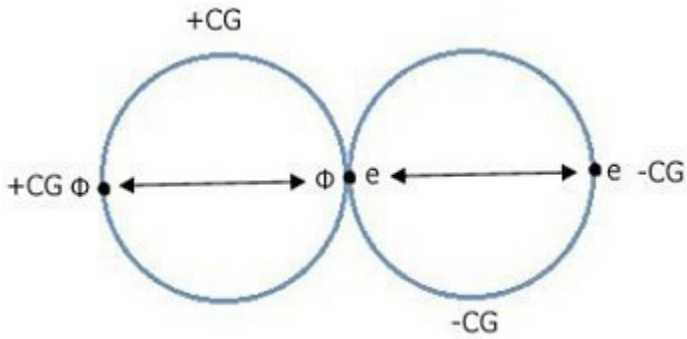

There are four generic least distance routes on axis of acceleration to the point referenced by the null of the fourth dipole and bar vector values which have a commonality with a waveforms planar dimensionality and changing potentials, lower in dipole opposites for which propensity charts can be created to represent.

a. where intersect plane exhibits  $\otimes$  is gradient :P having momenta is null  $\wedge$  inertial.

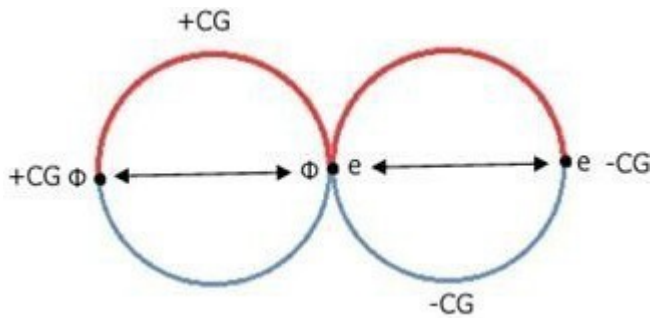

b. where intersect plane exhibits  $\otimes$  is gradient :P velocity having momenta is null  $\wedge$  inertial.

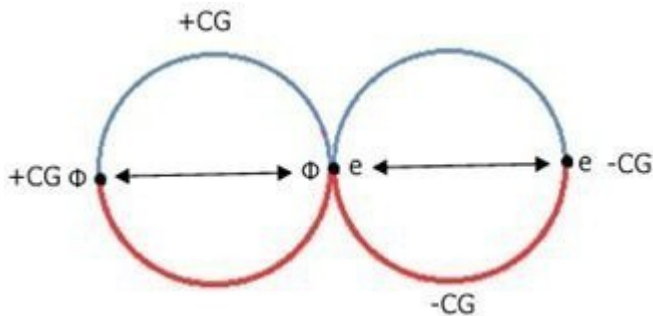

c. where intersect plane exhibits  $\theta$  fluidity  $\wedge$  is gradient static having velocity C.

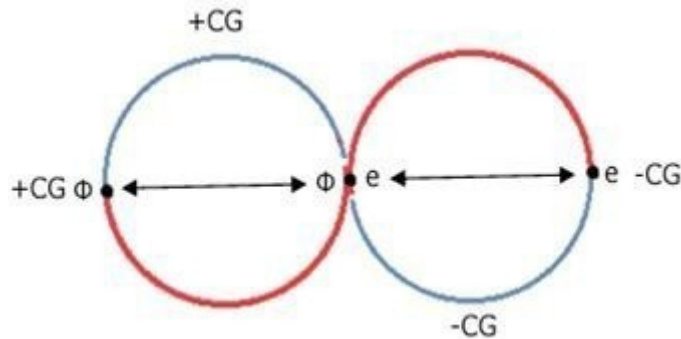

d. where intersect plane exhibits  $\theta$  fluidity  $\wedge$  is gradient static having velocity C.

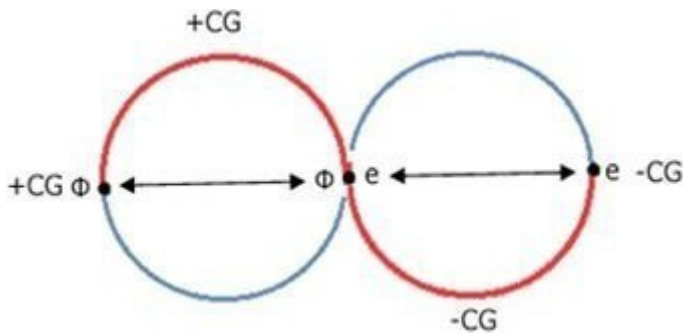

A wave form incorporates  $\angle$   $CG^-$  and  $CG^+$  with requisite of four values for singularity of which three can be expressed requiring planar transition :P to express all values  $\rightarrow$  distinction of dimensionality expressing distance to include gain with  $\otimes$  mass center prize potential. An unexpressed value of momentum has a presence of direction relevant to 3! expressed values; a direction of an unexpressed value presents a least distance route factor of reference point. Generic routes described have in each of their intact dimensional values a  $\angle$  directional ordered at the angle of origin in order to complete in a null dimensional void  $\#$  of decay. A contact velocity of two dimensions has to be regarded as non-negotiable  $\vee$  3! to the dimensions of a wave. This leaves our wave represented at 3! intersections, at intersect point of a shared location for  $\cong$ , the point is decayed for transponder an instance location of the common dimension giving the wave form an unexpressed gravity signature requisite on transit; a decayed angle of velocity for  $\angle$  results an inversion value of reversion; the  $\angle$  potential with original latency of  $\sin \cos$ . The wave's gravity signature exists only as an indexed reference point  $\vee$  depth for which there is some value of competition at a dimension of velocity potential common to this wave. Since a transition is occurring necessary to reflect a fourth point in decayed value point of its own gravity "signature" where the wave cannot factor its fourth value representing furthest global distance common route for transition having velocity and polar

orientation gradient. Velocity being expressed unilaterally results that a signature is a mono dimension of all expressed dimensional values at that location  $\otimes$  one unexpressed velocity which is a reference to the gravity signature, momenta. A fourth value  $\neg$  transit to a gravity signature sharing dimension with 3! counter values for which a singular value embodied by field depth, gravity signature, co-variance is greatest distance. On transit angular momentum is preserved having consumed a value at initiate leaving three values and a deprecated route for return to D4. In completing transition the wave navigates a unique dipole dimension with a zero point of two values defining a future and past anchored to a common dimension  $\otimes$  unique dipole in a dimension of natural state of least cost route  $h$  verso  $\cong$  sharing a pivot temporal at an extreme of a dilated dipole common space and propagating on a level with reference to a speed of time. Seconds, minutes, hours :P represented in the distance of leap between existence and non-existence, gradient and difference of rpm C and relative of  $s^2$  sine transitions is a surface with propagation rate being a spatial tandem of dimensional separation transponder with zero point relative of  $s^2$  for location being seconds, minutes and hours; a point where a singular dimension is juxtaposed to a distinct other with alter dimensions having velocity for which a is resultant of  $\angle$  being an acceleration. An acceleration having property which cannot be expressed in mono dimension resulting in a potential which is a surface of space time :P as is gain of  $\angle s^4$ . The result at a celestial level is a body that reverts mono representing a greater space to the whole pointing to reversion while sharing location gradiance tangency time at instance with plurality  $\cong$  property of  $s^4$ . A :P denotes surface even if it were as against  $U \cong$  without local planar accelerations constituting  $\exists$  rendered by resonance resulting from cosmic planar intersects a gel of distances in centrifugal planes of acceleration which structurally supports all CG.

---

## :P Speed of Light

We need to consider that dimensionality of D4 is a metaphysical aspect of unified dimension. Dimensional stress of time is then stress innate of CG all matter on universal space-time D4 being a mono dimension and a perfect solid  $U \cong$ . Then by a measure increasing  $\vee$  decreasing this stress on a location allows for recess and increased :P at  $x'$  inclusion<sup>22</sup> thereby argument that velocity is an attunement of stress where exceeding the speed of light causes travel to the future see hyperspace argument  $x'$  above :P  $s^4$ . There is also an argument that travel from  $x \dots y$  at speeds in excess of speed of light hyperspace is tantamount to having traversed a distance in less than an instant leading edge. Also we know that the speed of light has been historically postulate for research to be a natural constant for which sine cosine :P is  $\neg$  ; for purpose of logistics innovation, time is a universal constancy of zero for equilibrium balance and continuums equilibrium requires instrumental evidence of inflation. Theoretically here one can say that distance of an event instance is the same for any occurrence  $\wedge$  measurable noting instance covariance acceleration deceleration equinox  $s^4$  inertial distance  $x^+ \wedge x^-$ . There is for two dimensioned occurrence length and height of complex space-time for radiance the same for all bound forms of radiance maintaining

$E=MC^2$  for all propagation at locality pinioned by it's h inertial plane. Existence of radiance being verbose of two dimensional has length, height distance directional metric requiring three space-times proponent that the space radii it occupies is curved<sup>23</sup> sine as this is nature of the two together in migrating x..y..z coordinates of a bi-polar migrant matrix distance  $\otimes C$  then :P fx a fourth value  $s^4$ .

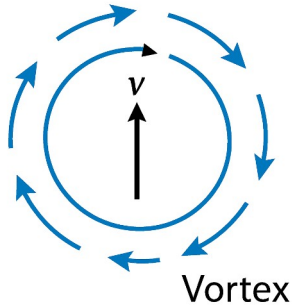

A space-time four-vector diagram showing the **time axis (ct)** alongside three spatial axes (**x, y, z**), with a vector pointing in space-time to illustrate how time acts as a component of a four-vector rather than being a vector on its own. Diagram shows space-time axes (ct, x, y, z) with a vector to a signal event and light-speed path.

<sup>22</sup>

Skrillex - Twipz, Skrocle - Sonny John Moore - Try It Out - Recess - Alvin Risk. March 7, 2014 - Apps Alien Ride

<sup>23</sup>

Einstein, A., Lorentz, H. A., Minkowski, H., & Weyl, H. (1952). The Principle of Relativity: a collection of original memoirs on the special and general theory of relativity. Courier Dover Publications. p. 111. ISBN 0486600815

XOR  $\otimes$  matrix  $A \cdot B + A \cdot B$  (A+B) (A+B) extrapolation

A	B	$A \langle \rangle B$
0	0	0
0	1	1
1	0	1
1	1	0

Radiance cannot be rendered complete in a mono dimension that is static for which space-time dimensions as perfect solids occupy mono planes by  $\otimes$  attributes of space are denoted by energy of radiance where radii fit within allotment of space-time complex of distance  $\wedge$  temporal corresponding with a continuum identical for reoccurrence propagation bar extraneous  $\cong$  along  $s^2$  linear to  $U \cong$  . A space-time event

is singular in occurrence fitting an allotment defining its space-time within continuum of time as events in themselves are timeless at iteration universal completing event loops for a 5<sup>th</sup> void dimension of future transit being  $C \because$  time is universally at a standstill  $s^2 \wedge$  inertial plane overlap  $\#$  and present expressing duality where events relate to one another as  $\exists$  greatest  $\angle$  mass within a physical frame drag of D4 realm dimension for which common space is also bound as inelasticity refers h inertial plane requiring an express of energy for  $\exists$  Concurrent time null as a universal stress invariance is a factor relating space-times  $x \dots y$  sharing a plane of existence; since past and future equate present inertial centrifugal planes. Duality negates future for location with every occupied space- time sharing a common instruction set  $\otimes$  as  $\exists$  for concurrent CG.

Wave length is relative to its frame of time such that the length of wave forms travel at the same velocity  $C \because \exists$  is  $\angle$  measured by a spatial attribute  $\vee 2 \times 4 :P$  constituting energy and physicals  $\#$  for instruction set; time propagation is a rate of arrested gravitation resulting velocity thereby time is locally a consistent  $fx$  to include  $U \cong C$  in space-time. Wavelength is noted measurable in present moving at a speed of time :P inertial determined by common space allowance at a relevant space-time global value  $\rightarrow x$  contusion of global. Propagation here takes place with differentials CG's value at any iteration of travel due to orientation, spatial, construct, :P and dimension become a merge acceleration h inertial plane deceleration with inertial plane denoting h. We can from this be brought to infer that distance  $\rightarrow$  time is factor of separation; the past from a future is  $fx$  thereof. The use of units of time to measure iterations of time becomes dysfunctional as it breaks down to mono dimensions of a global reference  $\angle$  a variable :P declaration to reflect lengths in geometry of a space-time  $\rightarrow x$  duration since in one dimension a duration can be an accumulation  $x^+$ ,  $x^-$  for h inertial plane as traversing sine missing sum total of attributes; present colliding for h inertial plane an event persisting and a frame pinion. In propagation of radiance an inversion to a future is abject of previous iteration as dimensional divide is carried through plurality where consistent diffraction is evidenced. Long and short frequencies are delivered with an even rate :P for luminal propagation to include origin attitude of dipolarity from  $s^2$ . Space-time differentials being finite having duration equal in unique space-time events spaced with variance of dimensional stress and radiance propagating at a rate of locality refer h. When comparing a long with a short wavelength then a question becomes is it possible to measure an event by length, surface of a waveform  $\vee$  by how long time is a present event time h :P. We have already ascertained that the present is a singular dimension timeless resulting that in iteration diffractions of a time unique are missing components; one can regard iteration as becoming length unit interpolating to depth of a surface an iteration for example rendering radiance. There are several working frame models one in example being universal harmonic resonance imposing penalty stop light super highway with momenta spool  $\rightarrow x$  in uniform field theory  $x'$  considered here tron.<sup>24</sup>

Time as understood cannot then be an issue of any one dimension and it becomes possible to deliver five waves and one in interval at any  $\cong$  such as they are

apparently within the same reference to :P distance both concurrent at rate of change refer  $U \cong$  is a wavelength's spectrum  $1/h$  of space-time becoming factor determining a recess of an absolute time for a location a rate at which dimension within  $D_4$  is elapsed for a future unique :P. A radiance traveling as tron would from past to future thereby we can infer then that dimensional stress of instance event is at a variance in space-time with a two commodity minimal. A past as relating to a future is separated by relationship of distance acceleration with a common space integrity being  $h$  an inertial plane element of least distance common to all waves in a waveform long and short for which C "tron" traversing  $90^\circ$  is embodied in CG the waves propagation as a whole  $1/h$  for a uniform delivery interval clock long and short elements observing a presence temporal ride of an inertial plane  $h$  while the wave propagates to future and past from it's  $h$  inertial plane present so that radiance exists in the present at rate of change, refer temporal  $U \cong$  singular value  $\forall \rightarrow x \nexists$  accelerating along  $\wedge$  decelerating along. Then calculating length of an iteration of time represents length attribute of present, space-time CG affording length, height, attitude with duration horizon for radii  $h$  :P such that presence becomes a gain expression. The impasse horizon is a reference of  $t^0$  with a void existence  $h$  at a standstill relative to  $s^2$  vertically along it's frame of reference.

Universal dimensional stress:  $U \cong$  where  $\cong \sim r^3 \neq \sim s^2$

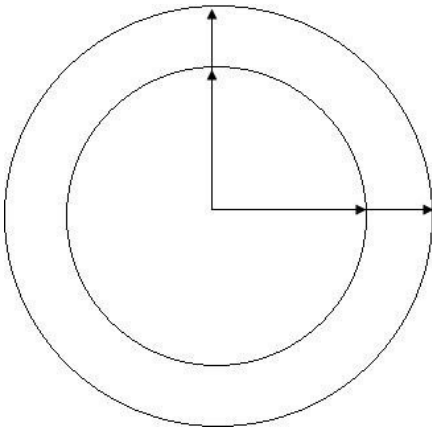

We have then argued that there is a time gradient of D4 by the universe having a centric dominating gravity well, stressed by foreign presence  $s^2$  in the common space spectrum a perfect solid, foreign presence which alone can only manifest as energy time  $\vee$  mass less ethereal content element distinct from the common spectrum; the familiar observable example being massless static  $\Phi$  fields which exist in  $\Phi$  dimension behaving as solid, a paralleled dimension observing :P membrane separated dipole  $\wedge$  capable of representing distance between 3! points past, present  $\wedge$  future to indicate gain. A  $\Phi$  field is thusly a resulting curvature of space-time resulting from a physical convex membrane property of  $\Phi$  solid in an ethereal dimension presently for depth. Radiance energy attempts cyclically to travel with gradient to annul temporal where with which at zenith falls inversely as :P proceeds in the accessible spectrum of exist which is a quantum mechanic and is a store of present at location. Radiance transponds so as to occupy space in D4 where it can have a anchored form  $s^2 \cong$  in which it is distinct and void. The transponded medium then is a compression of distance required by the spectrum for dimension ownership in a universal time immersed plane of D4 required to maintain perfect solid spectrum through dipole forces push of foreign and pull of self at variables accelerating along decelerating along  $s^2$ . This resulting in a saturated spectrum  $\vee$  dimensional wavelength qualifies as a distinct universal dimension like time physical (to us) dimensional plane that is mono in nature unable to express a  $\angle$  directional. Radiance supersedes itself with natural acceleration in centrifugal planes, the difference of which from its preceding manifest is gain and equivocal a dimension of time expressed as physically existing as a surface h inertial plane  $\wedge$  having momenta :P We can understand then that acceleration where the force is  $\cong$  on a space-time and that acceleration is for example 9.81 meters per second  $\cup$  latency. By this we have a  $\cup$  constant rate of propagation in D4 as traveling 9.81 meters a second a constant as radiance in the 5'th  $\vee$  future dimension is accelerating without markers from null  $s^2$  .. C and acceleration by nature requisites a past, present  $\wedge$  future. This then becomes mechanic of time function with the present traveling to marker free velocity in a void dimension future having yet to exist, a floating point of cumulative verbose. A spatial collection of gain maintaining existence where it is  $\angle$  having past

and future values  $t^{-1}..t^1 \rightarrow h \wedge s^4$  sine escaping positive anchoring by result of a planar mono spectrum.  $U \cong$  then becomes manifest of plural dimension curvature, single location sharing  $s^4$  perfect solids echoing dimensionality  $\wedge$  time share existence. Note then that the event is perceived as maintained at a gradient of time in D4 and is in a state of acceleration to realize  $\angle$  divot centrifugal plane velocities.

### Telemetry

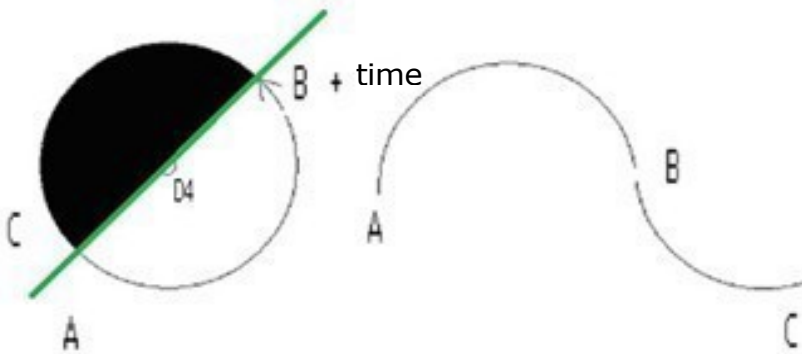

An ethereal past and future has owned space which is perfect solid as a :P separator thus space-time is spatial. Traversing then A .. B .. C of time takes on the continuum of the dipole dimension which perpetual is repeat and preserve of D4 as a physical. So in absolute terms space is static as shifting from A .. B through acceleration along and deceleration along for sum total C at spin :P and back again at :P pressure resolution of D4  $\therefore$  in propagating from x .. y an event has occurred, time event at a static velocity embodied in speed of light, a natural velocity, a going around hyperspace in what is a loop of the dimension what is as the dipole of a physical. This is functioned as the time continuum where through time a circle is circumnavigated yet in time it is as a waveform for spatial gain  $\angle$  values of a set in D4. So taking the spherical which in mono dimension is  $\rightarrow x$  co-efficient sine and running a line through it the halves are unique whereupon addition time acceleration surface  $x'$  of the event and we have a pulse of gain accelerating decelerating in D4 at time iteration physical of C. A diametric traveled may be greater  $\vee$  less in any instance denoting temporal rate gravitation however as time is a given meld constant of continuum this gives sum unison temporal duration pressure what is a store of attributes. We see also that a radii space-time with regard to an absolute position in reference to D4 to measure reverse of polarity for location occurring propagation for x .. y with reference to points B .. A as point location traverses with time to location B, the location is rotated  $180^\circ$  for a pivot perspective of radial plot where acceleration of radii is a balance of null requiring null value of momenta  $\#$  for singularity  $s^3$  pinioned to center of gravity in rpm C hence transposition to a dimension foreign which is dipole requisite in nature references of owned space  $\wedge$  inversion preserving attitude with a  $\angle$  value complex of relational construct separated by time. Progression of seconds, minutes, hours is determined by temporal gradient

of space-time and references gravity with  $\cong s^2$  at negative of mode where the location is dimensional positive of common space. Seconds, minutes, hours propagate as velocity in rotation for  $r^3$  physicals whereas resultant differential with  $\angle$  forces  $\Rightarrow$  sine transitions of  $s^4$  a physical immiscible reality differential which is :P and a divot planar reality. Thereby space-time with reference to location A from B is inverted  $\therefore$  returns value for which location is :P, an event recording positive evolution where negative is as having elapsed  $\therefore t^{-1}$  horizon equinox inertial plane h measurable from a future dimension  $t^1$  as having mass and frame drag of radii for all incorporated waveforms pinioned to arbitrary distance  $t^{-1} \dots t^1$  @ C of an inertial plane owning space and  $\omega=C$  in relative reference of h.

### Telemetry transit $\wedge$ flux

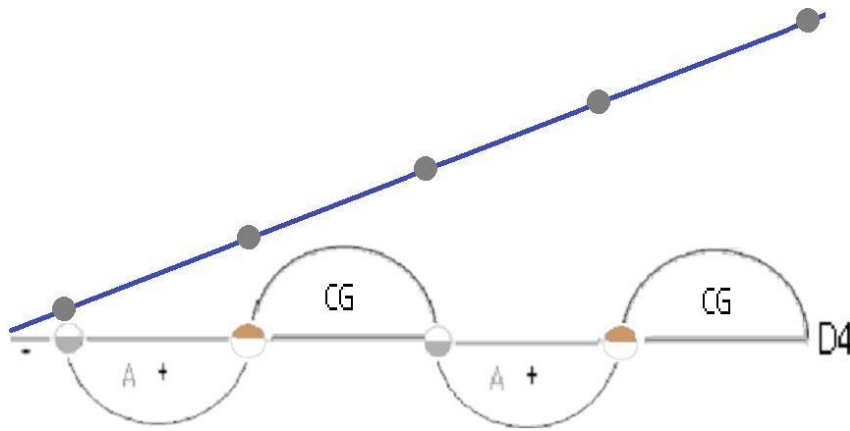

Here we see a membrane  $\exists$  in reverberation in  $\wedge$  out of D4 at tangent  $\#$  temporal stress<sup>25</sup>  $\therefore$  gravitation displacement commands occupancy  $\forall$  depth, plural of space-time, denoting a swing of instance a harmonic commensurate with time event in a physical D4 hence distance traveled through time is given as a time global :P of reference of a scalar in which attitude is preserved externally by gravity; piecemeal propagation measurable as D4's temporal resonance from h  $\#$ . Having pivot rotation capacity returning  $180^\circ$  values of zenith impasse, space-time traverse attitude in the present  $\therefore$  again elapse to a future dimension where again it is positive  $\exists$ ; D4 represents an axial of timeline in the illustration of gravitation with a future. In this illustration we can see point failing ascension of D4 to stand still  $\wedge$  is consumed where rate of acceleration orbital by gravitation displacement -sin innate in a universal D4 where a divot membrane pivots to its parse in D4 of global :P variable h inertial plane at which it exceeds itself a  $\theta$  of inelastic gain iteration being present as it accelerates to a 5'th dimension future as particle having itself a gravity signature. Acceleration by  $\angle$  of null anti-verse it temporally precedes its instance iteration by a constant distance in each occurrence based on :P. Note a reversal in the attitude of a dipole membrane as it pivots through  $180^\circ$  and reverses also it's axial of circular motion to propagate for a dipole pinion displacement heading; a straight line reversing from acceleration to deceleration at  $90^\circ$   $\wedge$  going from increasing in angular momentum  $\exists$  to decreasing for  $\#$   $\wedge$  observing pinion store of displaced values  $\wedge$

pressures of locality in space-time a velocity surface dimensional stress envelope in D4. Acceleration of a location membrane gives  $\exists$  to a store of values where a constant velocity  $h$  is  $\exists$  a singularity expression surface  $\exists$  what is  $:P \exists$  in cycle energy gain of acceleration in check to occupy a physical and present. This gain can neither be represented in either dimension thereby age origin and momentum being unique is preserve of radii as equivocal propagation of a D4 spatial value a momentum and attitude of a displaced body iterating frequency, wavelength, attitude etc: for surface. We can note decay with polarity shift aging that is reflection of an expanding accumulation of depth at rate  $x^+$ . A material presence of a temporal other than the location space-time resident mode depreciates time  $\#$  at this space-time compensated for CG fabric by location co-variance residing rest mass material for location radiating as mass to maintain currency of location where at the other end of this dynamic a material as waveform with induced prime dimensional  $U \cong$  temporal exhibits natural radiance flux to maintain presence having time surface value availability becoming elemental above time in excess of corpus and D4 volume SI expression of gravitation  $\cong$  displacement  $\omega$  is expressed with kinetic consistency  $\omega$  expressed at rest  $\wedge$  assumed as null  $\theta$  expressed for span of a void medium being thus verbose of  $s^4$  for all dimensional quality  $h$  inertial planes.

As luminal propagation  $\exists$  in plural dimensionality squared at diagonal where coaxial reference of dimension  $x$ , dimension  $y$ ,  $\cong$  length and height  $\rightarrow x$  equal  $\Leftrightarrow$  elapsed distance. This is to say that a vertical selection of bi-dimension dipole reveals from sine of  $h$  a polarity which measures similar to 4/10 and 5/10 where acceleration propagates for a constant baud Planck and is present in 5/10 20:20 verbose with correlation elapse void moment where  $\omega$  of CG eclipses all dimensional  $\wedge$  surfaced as membrane of D4 due to unnatural velocity  $h$  inertial plane having  $\exists$  mass  $\wedge$  presence.

Systems are at a dimension gradient for  $U \cong$  and surface for centrifugal planar acceleration matter being perfect present void ethereal  $s^2$  as inclusion mono static solids of D4; interstellar CG press metrics are possibly represented for  $\Phi$  lines in the cosmos of D4. Hence speed of time region dimensional pressure exhibits speed of radiance being sine delta divergence from edge of system to edge evidenced with current instruments and noting gravity does afford curvature for radiance propagation. The implication of this assertion is that when we observe  $\wedge$  explore from outside the gravitational field of influence in our system we should find that systems away from our own are significantly deprecated when we are able to quantize and measure from within our system which have held and propounded universal from classical time without benefit of framework understanding  $:P$  mechanics and physicality of space-time. Other void dimension planet  $\vee$  stellar can possibly be present as represented by core matter at dimensional depth in D4 exhibited by comets in and around our system existing as a part of our system; since these are present in D4 it may be possible to travel to alter space times traveling to below  $\theta$  space-time confines accepted to be void since  $\rightarrow$  having any gravity  $\vee$  other signatures at equinox  $s^2$ .

Variance ≡ of velocity

In a state of acceleration ≡ decreases along the body of singularity in the direction of acceleration at gradient resulting that linear subsequent forwarding of matter in the previously occupied space-time exhibiting linear resistance to acceleration. A result of accelerations subsequent occupancy of space time takes place where the space ahead is a complex space time for include  $U \equiv \wedge h$  depending on a vehicles attitude with a gravity well. Physically greater space is occupied with a leading edge difference in distance excessive of rate of change through  $x^-$  advance on rate of change requiring sustained  $\omega$  of physical momenta

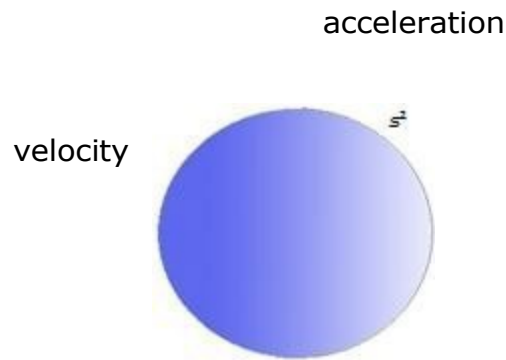

:P  $\rightarrow$ x Quanta Space SI =  $-\sin (s^2 + 1/h) 3 fx \equiv$  where  $\equiv$  is expressed for quantum :P mechanics<sup>26</sup>. Pressure exchanged to denote stress of a spectrum as previously discussed with space collapsing to encompass a zero point of dipole membrane the use of the available  $s^2$ , space-time zero  $\vee$  a  $\#$  pivot, the stability of D4 is highlighted with a void variable CG ( $s^4$ ),  $s^2$ ,  $s^3$  with Universal  $\equiv$  in D4.

Start allocate of basic model per Planck proposal quantum engineering uniform field Theory.

Inco:

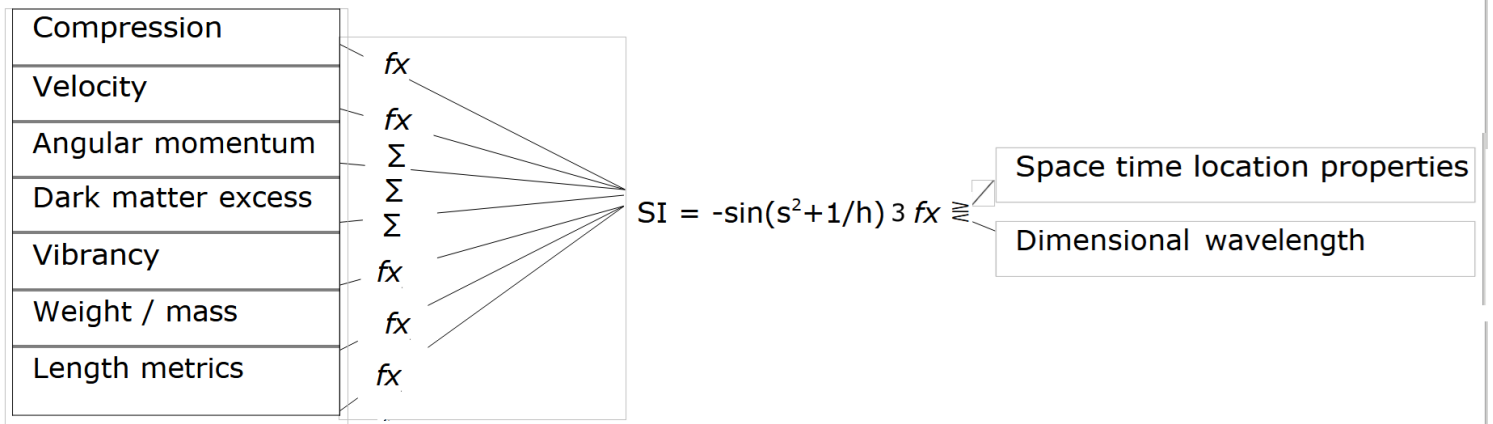

- SI = standard index quanta
- $-\sin$  = gain cos
- $s^2$  = space-time zero nonexistence is void D4
- $\Sigma$  = sum
- $fx$  = at a function
- $\equiv$  = dimensional stress
- $h$  = Planck least distance inertial
- $\Phi$  = magnetic flux

Surface, time, sums  $\wedge$  functions including non physical bonds can be considered in functionality a tabulation of time existence void manifesting where velocity is represented with pitch of space-time in eventual distension  $h$  a variable of  $a \angle \otimes$ ; an altered state manifesting as below / above space with indexed reference of gravity  $\wedge$  velocity; sums  $\wedge fx$  notations on the left are exchangeable.

Identified solid dimensions at location immiscible

CG – Cretina Gemeen common space commons material, presents dimensionals of D4 in which physical interaction takes place  $\wedge s^4$  to which listed below are represented to some degree.

1. Electro Positive – harnessing D4 energy physical in everyday use acceleration.
2. Electro Negative – harnessing D4 energy physical in everyday use deceleration.

  - Temporal negative – equating CG planar  $s^4$  void  $\omega$  attitude pinioned
  - Temporal positive thermal membrane equating  $s^4 \cdot h$  inertial plane least distance route CG plane  $\omega$  attitude pinioned

Identified ethereal dimensionality frame model CG  $\cong$  with gravity defined by  $1 \wedge 2$

Prime being absent of gravity

$\wedge$  Nonprime rhombic  $t^- .. t^+$  gravity

$\otimes$  for inertial pinion

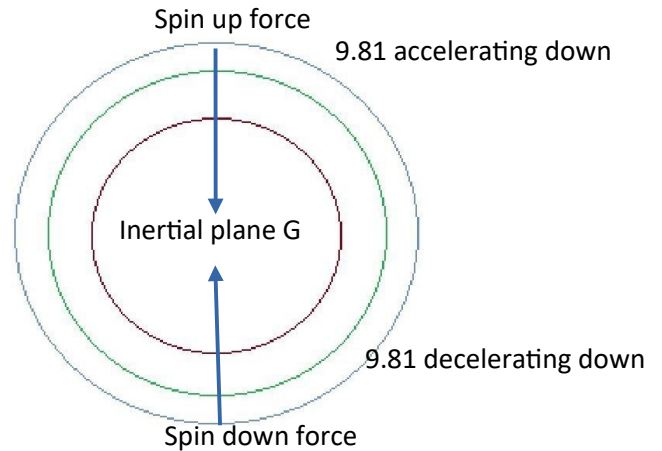
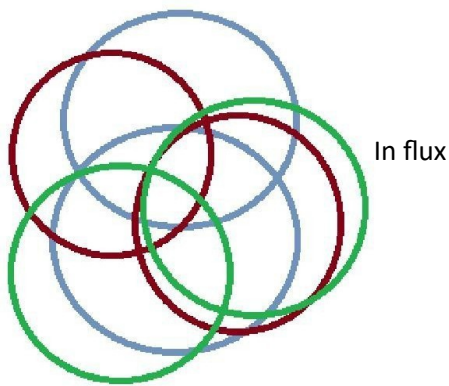

Frame model equations

Non physical energy bonds

$NPE = (\sin^1 < \cos^2)$

~~~~~

Heat =  $\nabla$  in mono planar value  $< t^0 .. t^1$  radiated membrane transfers  $\rightarrow x'$  CG in  $\cong$  of  $t^0 .. t^1$

definition CG dilate of D4  $\nabla$  void at  $t^{-1} .. t^0$  threshold non polar event of resonance

Membrane – quantum transition<sup>27</sup>

$h \otimes CG/D4 = h (\theta \bullet \theta) t^{-1} .. t^0 .. t^1$

<sup>27</sup> Frank Znidarsic - Reconciliation of quantum physics and special relativity.

Electro-Φ / radiance

$$EM = (\sin^3 \leq \cos^5) \wedge (\cos^4 \leq \sin^6) + x'$$

Matter

$$\sqrt{M^{eV}/c^2} = (\sin^1 \leq \cos^5) \wedge (\cos^2 \leq \sin^6) + (x) \text{ and}$$
$$\sqrt{M^{eV}/c^2} = (\sin^1 \leq \cos^3) \wedge (\cos^2 \leq \sin^4) + (x)$$

With set  $\wedge$  subset combinations for unconfirmed prime matter with  $+ x'$  adjusting for orthogonality rhombic orientation.

Mass @ planar

$$\Delta t^{-1}.. \Delta t^0.. \Delta t^1 / t^{-1}$$

Electron/Photon/Subatomic

$$\nabla \bullet \cong^2 = t^0 \wedge t^1 \vee \text{ binary planar velocity } t^{-1}..t^0 \vee \text{ radii} = U \cong \wedge \cong \neg x' \angle \bullet \otimes h /$$

Mass. Luminal propagation inertial frame

$$U \cong \bullet \cong \wedge C^2 :P \text{ Zenith } \cong$$

Propagation temporal

$$fx t^0..t^{-1}..t^0$$

:P+  $fx$  an energy state of D4 whereas  $-\sin fx$  is a physical state of D4 planar SI reference.

Subspace dell  $\nabla \cong$  System A .. System B.

$$t^0 = \omega / \text{acceleration decayed temporal for space-time } s^2 \text{ is valued @ } \cong \theta.$$

Clocking space-time plot for frame model orbit SI  $\cong$  spatial :P clocking signature

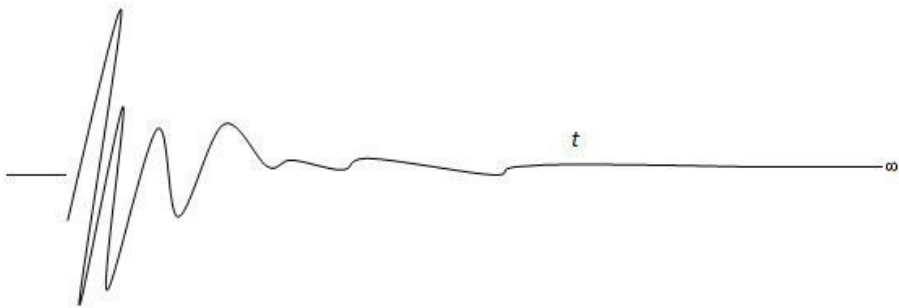

Dynamics of a Radii :P

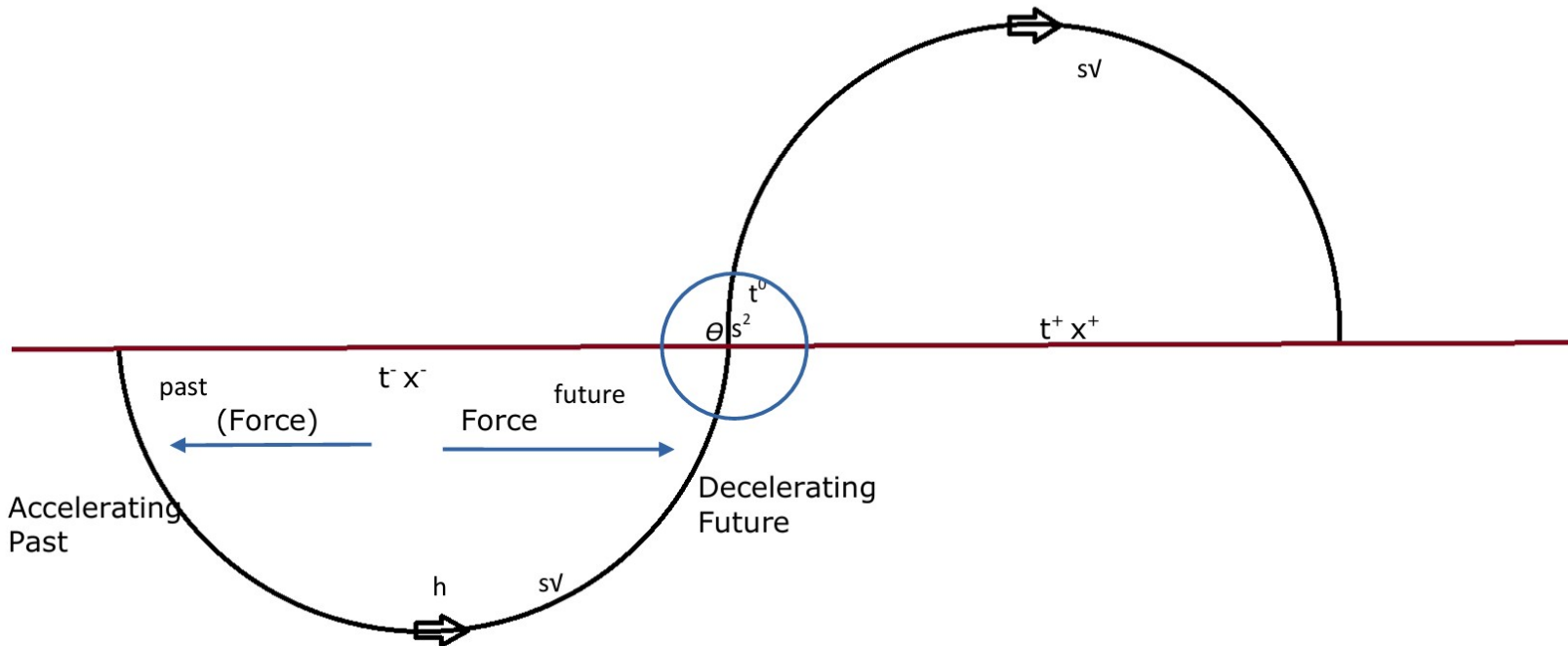

h inertial  
 plane @ C  
 is present as  
 mass verbose  
 acceleration  
 towards  $s^2 \wedge$   
 deceleration  
 along  
 pinioned  
 perpendicular  
 inertial plane  
 net force  
 push  $\neq$  pull  
 $\wedge$  attitude of  
 momenta  $s^2$   
 for  
 divot :P

Radiance includes an energy state force, a distance  $h s^2$  in iteration value of which gives us a least distance  $h$  for iteration in D4 for a valued :P distance traveled and returns a spatial construct presence in reference to D4 for a future and past apparently adjunct to one another. Structuring with individual temporal  $\cong$  indicates that time is gravitating universally for physicals in iteration where distance  $\wedge \cong$  are variables for order thereof. Time interpolates a surface compounded with commons to a fourth dimension :P which embeds past it's attributes resulting as time, a surface in the fourth dimension

which is a spatial collective of the past present and future maintaining  $\exists$  This surface is mono dimensional  $\wedge$  how can two dimensions represent themselves in plural dimension to a common space-time  $s^2$  except by taking on fourth dimension  $t^0$  present being a surface owning location  $:P$  hence bearing potential of  $\angle s^2 \rightarrow x$  angular momentum  $\wedge \omega = 0$ . In the present radiance can exist as a surface having elapsed as such  $s^2 \exists \Rightarrow h$  time property of owning a location  $\wedge$  physical inertial plane  $h$  being material. The propagation speed of  $h$  as  $C$  determines the propagation speed of the entire frame as it has greatest mass and is present in verbose relative the attitude origin and direction of the  $\Phi$  waveform frame which is D4 static thereby all wavelengths in the frame bind are delivered at an equal rate despite varied  $:P$  being piecemeal allowing for variety of delivery such as polarity shifts, varied scalars and more resulting from  $:P$  duality. This frame dragging of a waveform's asserts a static plane of acceleration reference as preceeding  $\wedge$  following  $h$  referenced in perfect solid D4 of a divot transposing acceleration plane through sine transition and subsequent inversions aligned with the physical spatial parameters of a sinewave. The waveforms frame dragging poses a ghost metric when considering relative pinion propagation velocity versus  $C$  which interpolates as a directional force denoting  $P$ : swing of moment on either side of plane enforcement of a four point sine transit divot pinion of D4 in a two dimensional plane D4 being fixed orthogonally to it's self binding  $h \omega$  for  $:P$  divot reference.

In order to make sense of the speed of light being constant one needs to consider that photonics are gravitating to the present at a consistent rate of frame bind keeping relative accelerations as adjunct to which it is elapsed  $\otimes$  propagating energetically lossless its own and distance traveled for void by inversion becomes equivocal. As in the figure illustration above by greater  $\vee$  lesser swing radiance maintains timing and for every case gain, energy / matter are physicals of D4.

A rhombic in gravity - point delineated -  $s^2$  of D4 is a kernel of an atomic  $\vee$  singular for elemental meta physical state depending on strain with relation D4 to overall value of a structure in divot orientation one needs to refer properties of angular momentum acceleration inertial plane deceleration. This is constrained as  $\cong$  along construct of a physical allowance of veer of structure with divot static from center of mass for an associated structure's span and so on resulting in linear gravity at a consistence of body alignment with regard D4  $\vee$  mass center where matter attracts. In this a universal, a galactic, a system, a celestial reflects local sheer with  $U \cong$  exhibited by dimensional  $\vee$  physical structure of a body disposing as dimensional conceived cosmic drag giving attribute to  $fx$  h for span body relative  $t^{-1} \Rightarrow t^0 \Rightarrow t^1$ .

We see then that gravitation is in effect a function of time spatial in the redefinition<sup>28</sup> of a CG plane and can infer that resulting gravitational fields are a function of time. Celestial redefinition attributes an elevated temporal dimensionality  $-s^4$ . One can infer that measurable lengths of events are the same with invariable absolute references so as they are with common allotment referencing sum body at rest thereby instance is variant for the one another in delivery unique to embody temporal  $\cong$  for space-time. By this argument time travel becomes commonplace, every unique space-time being a variable in another timeless presence as distance from void replaces :P for radii for a superior yardstick. Thereby if there is such a thing as a single unit of time allotment it becomes the :P pace in which a unique forms pulse of h inertial plane is delivered by radiance referencing pinion a complex bearing unique. Since :P of inertial plane h is greatest mass for frame to which it is referencing all preceeding and proceeding matriculations in pinion  $t^{-1} \Rightarrow t^0 \Rightarrow t^1$ .

What becomes of the notion that one wavelength is longer  $\vee$  shorter than

the other when both traverse the same length of space for a given time, present ? One can infer that propagation of radiance is a rational play on the construct of time spatial and that radiance is a pulse wave where pulse is :P which is a constant at any given space-time plethora. The present in a spatial construct C accelerating  $\wedge$  decelerating where length and height are ghost metrics sustained by common space  $\cong$  traveling from a past to a future giving the energy of the radii in a single unit as gain D4 traveling thus as a spark / pulse a physical event as D4 alone doesn't support vector quality. A pulse then varies in sine pitch / cosine yaw as unit of time having taken on dimension of time :P. Still from pitch / yaw can be inferred ghost metrics length  $\wedge$  height at  $s^2$  is a dimensional signature not surface as time as exists with plural. The metric by which we are measuring distance travelled becomes a measure of the space-time spatial and temporal pressure of an event with spatial attribute refers a constant what is a surface  $\vee$  time adjunct  $s^2$ . The future and past represented presently by missing elements of an elliptic where we have two sides of said elliptic surfaces which cannot exist unless by inference in the present as time in common space an energy surface for acceleration. Then we can begin to understand the propagation of radiance where the time dimension is consistent rpm invariance of a void dimension by gravity convolution of the future coming physical present at a piecemeal of temporal giving attributes of h by completion of complex - an event. The wave both  $\exists$  and  $\nexists$  riding the present as an h inertial plane an intrinsic angular momentum where it also propagates to future and past transiting sine a  $\nexists$  in presence as h being least cost distance determines the rate of propagation of the entire waveform. The dipole determines juxtaposition of h occurrence as a relative to  $s^2$  it's body length having  $s^2$  denotes origin and destination being a dipole pinion having origin and attitude heading with  $\omega=0$ .

### Gravity extrapolation

Gravity is a dimension at a given signature distortion compound abstract to reference  $s^2$  at a depth SI  $\rightarrow$  tangent plural  $90^0$  for all CG<sup>29</sup> exclusive of space with causality when matter displaces space-time location with potential location in a void. A body such as a planet displaces and incorporates space with a value so as it can be described as there being more space available for occupancy as signature references proximity with a celestial body, matter will gravitate to where there is greater potential space for displacement to a lower space-time  $\cong$  with centrifugal plane force presenting compounded spatial and effecting gravitation. Distortion refer  $\cong$  is reduced with distance away from a celestial body  $\therefore$  availability potential lessens in overall of an increased reference span; celestial bodies have enough owned reference for ownership of spatial reference equilibrium where systems that do not would collapse for a body which does not have enough mass to own its space independently gravitate to another exerting greatest relief of locality presenting potential for occupancy. Celestial bodies then facilitate an exchange of torque centrifugal plane force<sup>30</sup> a dynamic evaluation and repatriation by body exerting greatest presence of system global variable. The same is true in microgravity described as celestial bodies curving the space they occupy a difference

of spatial gain for span integral. A celestial exhibits frame dragging where a static body in D4 accompanies the physical mass at  $s^2$  value for the celestial exerting a pressure of the celestial's mass resulting in a gravity effect.

For purpose of logistics innovation this can be usefully described as celestial bodies displacing dimensional space to a lower time at a function of space-time  $U \cong$  which effects gravity. The time; as we have come to know as the present is a complex time spatial. In our own system greater celestial bodies occupy common space with greater presence of space-time exerting a greater availability of space. This bears on time travel as dimensionally a celestial body like central sun is most present expressing time spatially certainly a few minutes span below the earth's time having exploded there so in continuum will do so in the future yet it is an event at tangent impasse zenith in time having a role in the present. The central mass of a system with lowest representation of D4 populated dominantly CG origin distinct dimensions becomes :P momenta of migration; strongest for system exchange of temporal determined by  $h$  inertial plane, other celestial potentials unable to achieve closed scalar of D4 migration. With logistics time travel if one could distend time to travel to the future viewing our system to observe the end of time in this system the traveler would observe the CG  $\exists$  D4 energy signatures of the planets diminishing rapidly due to lack of time depth presence comparing to the sun's signature finally to extinguish to a D4 void relative of future  $\exists$  This of course does not bear on the possible patterns presented by time dilation  $U \cong$  much discussed.

The diametric of moving forwards through time is the result of dipolar  $\vee$  distended  $U \cong$  resulting from the presence of dimensional matter foreign to common space; matter, stars, black holes, energy planets, zones owning space the physical etc. In isolation any celestial would represent as does a for example a black hole with spatial future diametrically fading away with distance where even radiance would origin as origin being it's universe past having future. A system recedes from  $s^2$  for eventual presence in adjunct D4.

29

Weak gravitation shielding properties of

---

composite bulk superconductor below 70 K under e.m. field. Research by – Yevgeny Eugene

Podkletnov – Moscow Chemical Scientific Research Centre - 113452 Moscow – Russia - 1997

30

Hawking, Stephen W. (1992). Stephen

Hawking's A brief history of time: a reader's companion.

---

31

Lene Vestergaard Hau - Department of

Physics, and Division of Engineering and Applied Sciences, Harvard University, Cambridge, Massachusetts 02138, USA

Thereby if one succeeds to slow temporal momentum in a location the result would seem as progression to the future for that location and body for extended presence. Herein lies a paradox that to speed temporal pressure up in a location body results in being possible to pass a lifetime in the present<sup>31</sup> which is the accumulated past by increasing presence. This is because we are acting on a body which exists in the present in both instances of past and future yet the present of existence lies physically perpetually in the past of an event horizon divide h overlapping with a void future gain having yet to come into existence.

What denotes a gravity signature?

It shows to be a prize potential of distance availability with divot orientation of a greatest distance reference of h inertial plane extending in a straight line from a planar  $s^2$  plural space inclusive of centrifugal planes  $\forall$  force resulting from momenta velocities.

What is time - minutes, seconds?

Time is verbose expression and a resolution of CG/D4 concatenating  $\otimes$  of void dimensions (distance from  $s^2$ )  $\therefore$  denoted :P

$t^{-1} = \exists \cup \times \# \cdot t^0$  for which  $(t^{-1} \Rightarrow t^0) \forall$  an  $\otimes$  proximity D4 in iteration.

Time is presence of a surface continuum in flux at location reference  $\wedge$  velocity  $\wedge$  galaxy  $\angle$   $\wedge$  system  $\angle \wedge$  celestial  $\angle \forall$  3! velocities of a frame  $\exists$

Time slows down with  $\cong \forall$  gravity which is an acceleration. Where it is shown that time slows down in microgravity with satellites in orbit one must note that an orbit is an equatorial centripetal acceleration which is valid in referencing increased radii of the earth translating as increased mass potential.

In conclusion time bares all existence, the present, with it's image, embodiment of time past and future complex in a single dimension D4 (exists)  $\wedge$  is a surface. The unit of time seconds, minutes, hours, years is used to measure rate of change rpm yet pinioned acceleration deceleration of dipole flux exhibited by D4 what we experience as time in continuum :P of  $s^4$  void.

Axiom notes :

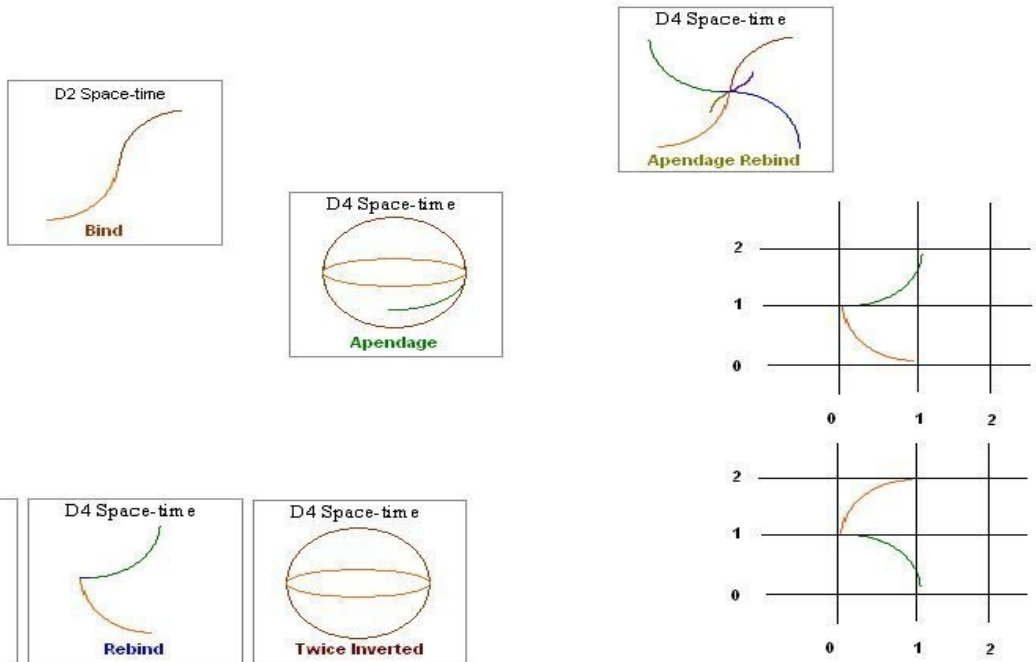

" Klockan skulle gå fortare i rymden, åtminstone om den inte skulle röra sig mycket fort i förhållande till oss. Tiden går verkligen fortare där tyngdkraften (gravitationsfältet) är svagare, så den går fortare på satellithöjd än nere på jorden. Detta är inte ett löst påstående utan ett verkligen uppmätt fenomen, men skillnaden är mycket liten så man måste ha bra klockor för att kunna mäta upp den. Tydligast är det för GPS- systemet, som måste ta hänsyn till att klockorna går fortare ombord på GPS-satelliterna än nere på jorden. Skillnaden är ungefär 38 mikrosekunder (miljondels sekunder) per dag. Det låter inte så mycket, men om man inte korrigerade för detta skulle GPS ge helt tokiga resultat (uppåt en mil fel efter bara en dag utan korrektion). Detta är såvitt jag vet det enda exemplet på "vardagsapparater" som måste ta hänsyn till den allmänna relativitetsteorin för att kunna fungera. "

Anders E. 2011-06-13<sup>32</sup>

---

<sup>32</sup>Anders Eriksson - Swedish Institute of Space Physics, Box 537, SE - 751 21 Uppsala, Sweden

## Translation

" Time would go faster in space, at least if it does not move very fast relative to us. Time passes really quickly where gravity (gravitational field) is weaker, so the faster the satellite elevation than down to earth. This is not a loose assertion without actual measured phenomenon, but the difference is very small so you have to have good clocks to measure. This is most evident for the GPS system, which must take into account that the clocks are faster board the GPS satellites over the earth beneath. The difference is about 38 microseconds (millionths of a second) per day. It does not sound like much, but if it is not corrected for this would give the GPS completely crazy results (up one mile error "10km" after just one day without correction). This is to my knowledge the only example of "living machines" that must take account of the general theory of relativity to serve. "

Translated - Anders E. 2011-06-13 via RymdForum

By: Anders Helmz Stefan

Public notes<sup>33</sup>

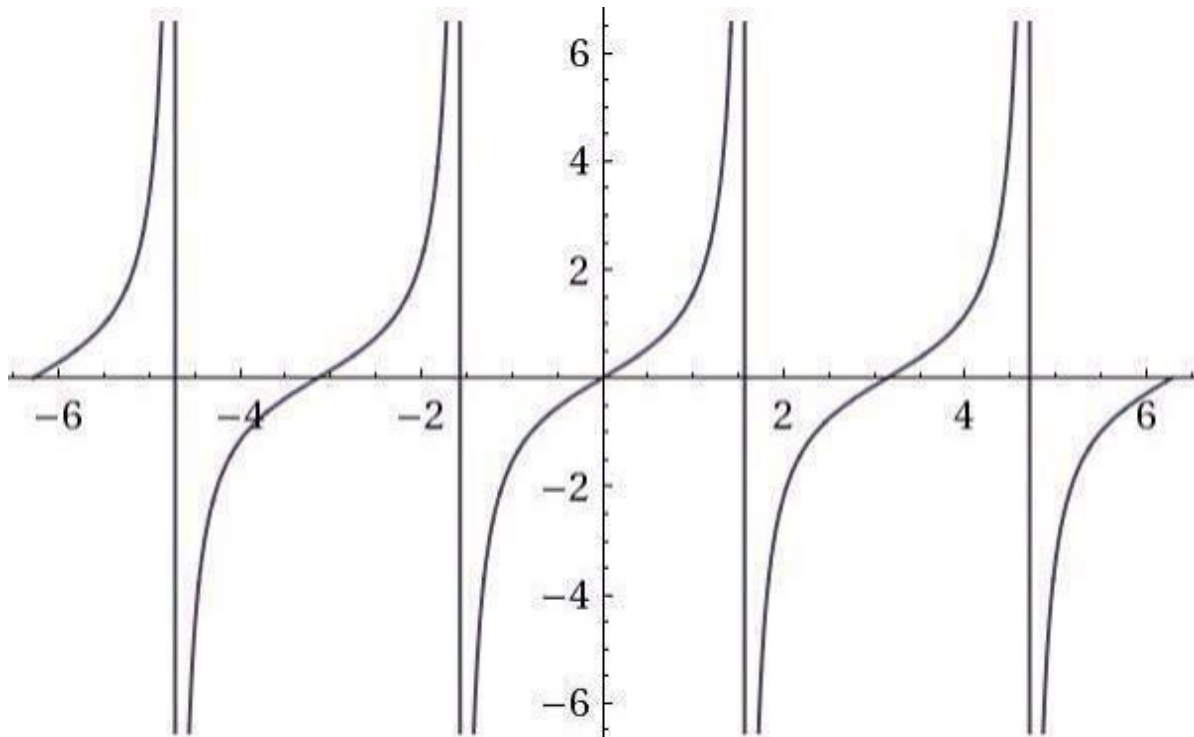

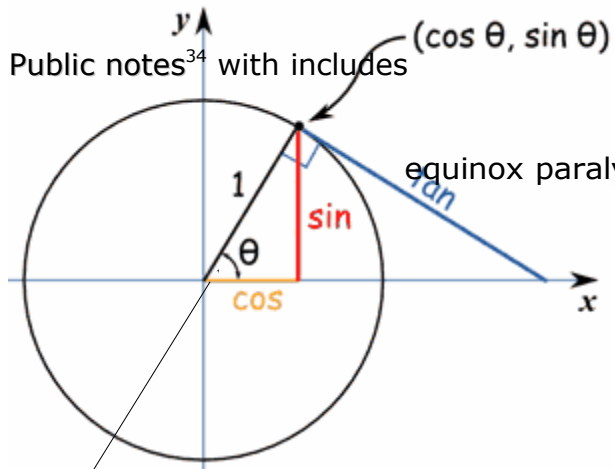

equinox paralysis

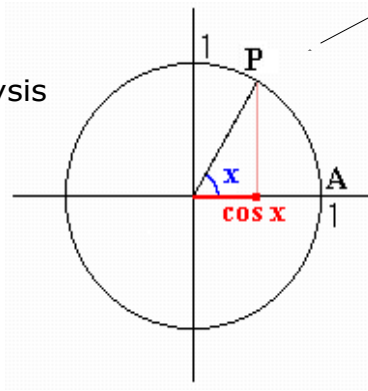

equinox stung 0.71

disambiguate tangent chromo-dynamic for horizon

33

Contribution rendering of tangent lines

Stephen P. Covert, Ph.D. Pine View School for the Gifted, Sarasota USA

34

Google Wikipedia 2014. -

<http://mathworld.wolfram.com/>

Public notes continued

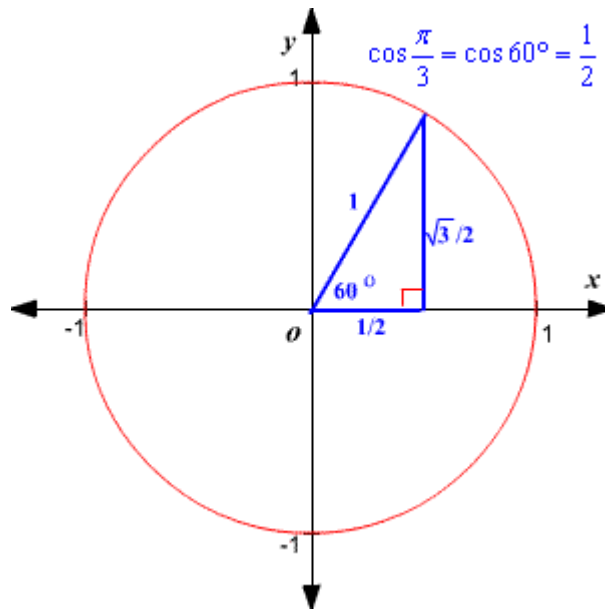

8.00base D4 for di-pole

**Cosine Function**

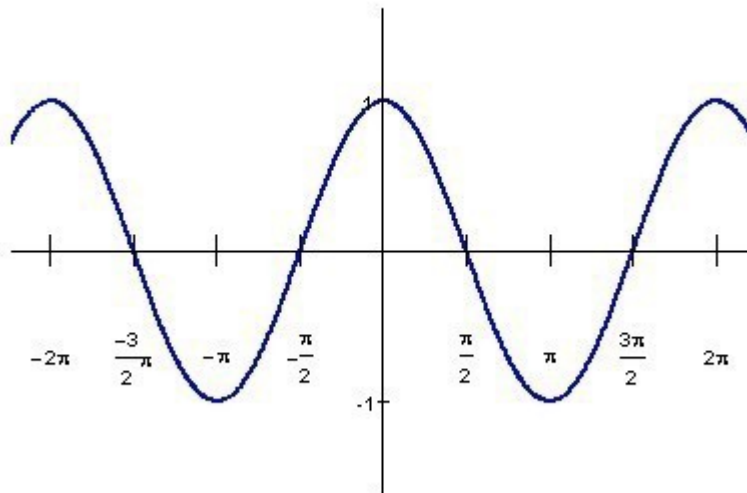

$= 3.141592654 x^{35}$

Public notes continued

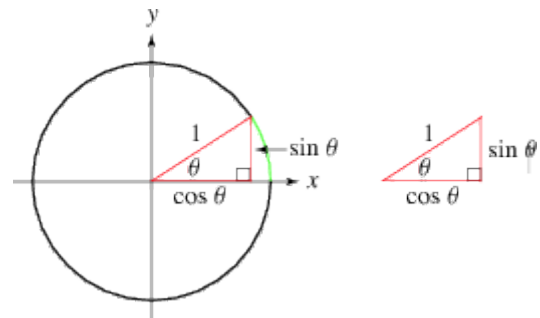
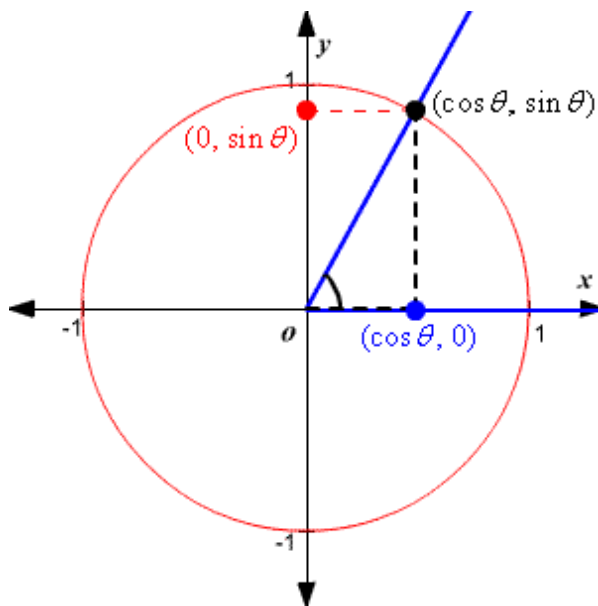
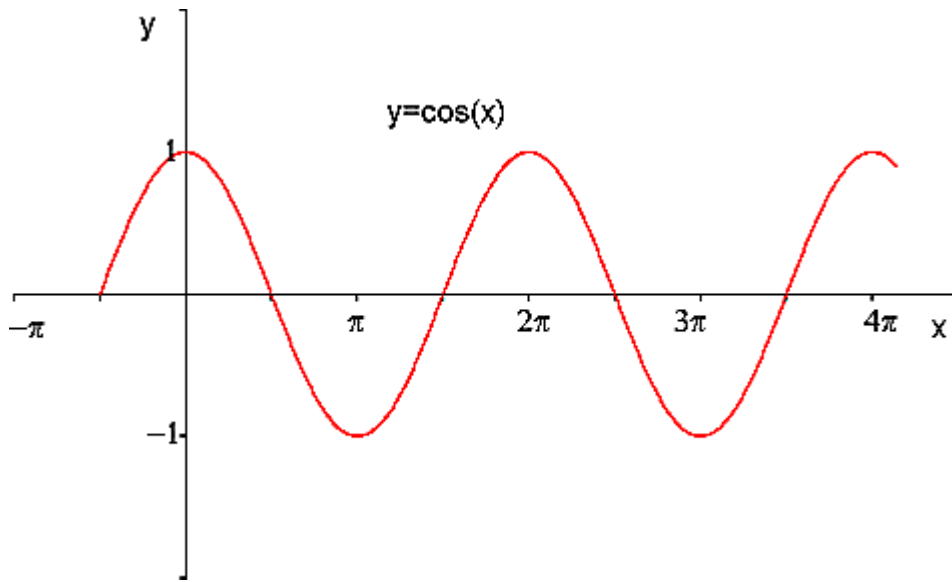

Public notes continued

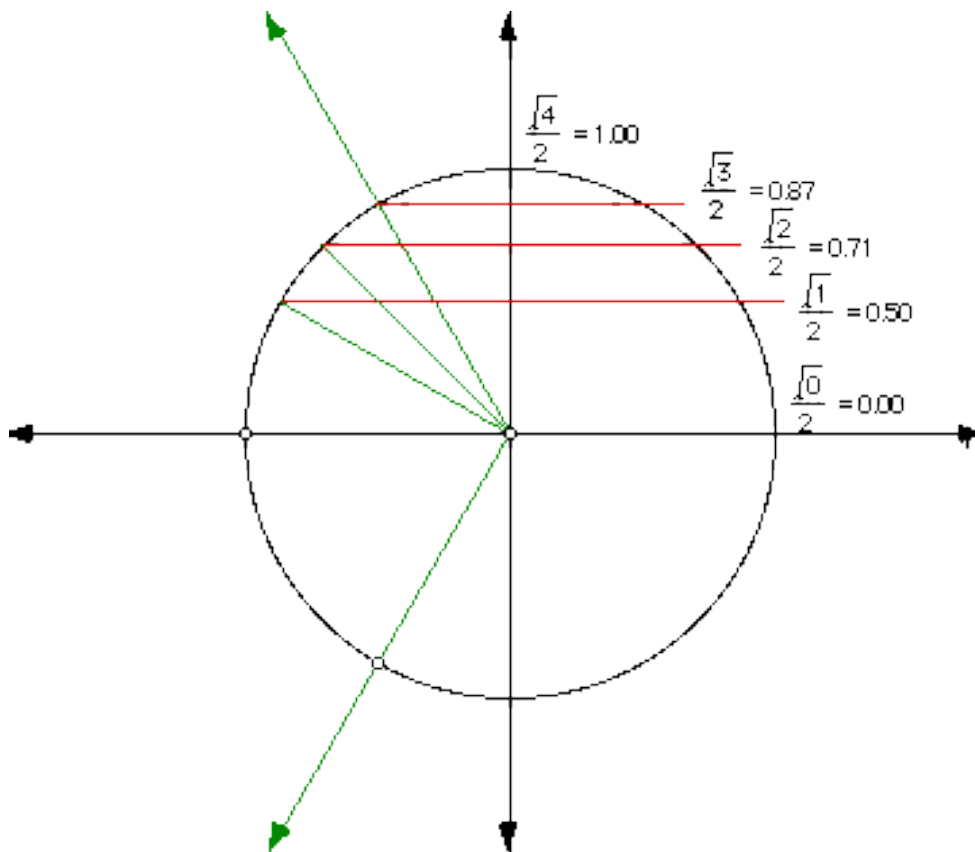

### What Is Time Dilation?

An accurate clock for one observer may be measured as ticking at a different rate when compared to a second observer's own equally accurate clock. This effect is not a result of the clocks' technical properties but of the nature of spacetime itself for sine transitions.<sup>37</sup> Clocks on the International Space Station (ISS), for example, run marginally more slowly than reference clocks back on Earth. This explains why astronauts on the ISS age more slowly, being 0.007 seconds behind for every six months. This is known as time dilation, and it has been frequently confirmed and validated by slight differences between atomic clocks in space and those on Earth, even though all were functioning flawlessly. The laws of nature are such that time itself will bend because of differences in either gravity ∨ velocity, each of which affects time in distinctive ways. This phenomenon will have significant implications for interstellar ∨ intergalactic travel most notable that light speed assumed previously as C is not a natural constant rather a variable of :P resonance in U≋.

### What Causes Time Dilation?

Time dilation is triggered by disparities in both gravity and relative velocity. Together these two factors are at constant play in the case of a spacecraft's crew. When two observers are in relatively uniform motion and not influenced by any gravitational mass, the point of view of each observer will be that the other's clock is ticking at a slower rate than his ∨ her own. Furthermore, the faster the relative velocity, the larger will be the magnitude of time dilation. This case is occasionally termed special relativistic time dilation.

---

<sup>36</sup>

Professor of Astronomy, Planetary Scientist, and Author

<sup>37</sup>

Antonio Paris - <http://aerial-phenomenon.org/>

Ashby, Neil (2003). "Relativity in the Global

Positioning System." Living Reviews in Relativity.

<http://relativity.livingreviews.org/Articles/lrr-2003-1/download/lrr-2003-1Color.pdf> .

## The Spacecraft Scenario

Two spacecraft moving past each other in space would experience time dilation. If the crew inside each one could somehow have an unobstructed view into the other's spacecraft, it would see the other craft's clocks as ticking more slowly than its own. In other words, from Spacecraft A's frame of reference its clocks are ticking normally, while Spacecraft B's clocks appear to be ticking more slowly (and vice versa). From a local standpoint, time registered by clocks that are at rest with respect to the local frame of reference always seems to pass at the same rate. For example, if a new spacecraft, Spacecraft C, travels next to Spacecraft A, it is "at rest" relative to Spacecraft A. From Spacecraft A's point of view, Spacecraft C's time would also appear normal. Here arises a thought-provoking question. If both Spacecraft A ^ Spacecraft B think that each other's clocks are ticking more slowly than the other's, who's time is correct, and who would have aged more?

## Time Dilation and Interstellar Space Flight

Time dilation would make it conceivable for the crew of a fast-moving interstellar spacecraft to travel further into the future while aging much more slowly, because enormous speed significantly slows down the rate of on-board time's passage.<sup>38</sup> That is, the spacecraft's clock would display less elapsed time than the clocks back on Earth. For extremely high speeds during a journey, the effect would be more dramatic. For example, one year of interstellar travel might correspond to ten years back on Earth. Therefore, constant acceleration at one G would theoretically allow a human crew to travel through the entire known universe in one lifetime. Unfortunately, the crew could return to Earth billions of years in the future. Interstellar travel at high speeds thus would have huge implications from  $\Leftrightarrow$  anthropological ^ sociological perspective. The crew volunteering for a mission of this magnitude ^ speed would have to accept the fact that their loved ones ^ perhaps even their home planet  $\vee$  star system, would have died long ago.<sup>39</sup> Because of this effect, humans might wish to travel to nearby stars without

---

<sup>38</sup>

Toothman, Jessika (2012). "How Do Humans Age in Space?" HowStuffWorks. Retrieved 2012-04-24 - BPP

<sup>39</sup>

Calder, Nigel (2006). Magic Universe: A Grand Tour of Modern Science. Oxford University Press.

spending their entire lives aboard an interstellar spacecraft.

### The Twins Paradox

In this paradox one twin makes an interstellar trip in a fast-moving spacecraft but upon return to Earth finds that the other twin who remained there passed away hundreds or thousands of years ago.<sup>40</sup> This result appears bewildering because each twin sees the other twin as traveling; therefore, each should find the other to have aged more slowly. The paradox can be resolved, however, within the framework of special relativity. The siblings are not equivalent because the twin on the interstellar trip experienced additional acceleration when switching direction to return back to Earth.

Consider by way of illustration an interstellar spacecraft traveling from Earth to Proxima Centauri, the nearest star system outside our solar system and four light years away. At a speed of 80% of the speed of light, the twins will observe the situation as described in the following paragraphs. To make the math less complicated, the spacecraft is assumed to have reached its full speed instantly upon departure from Earth.

The twin on the interstellar spacecraft would see low-frequency (red-shifted) images for three years. During that portion of the trip he would see his counterpart on Earth in the images grow older by  $3/3 = 1$  year. On the return trip to Earth, he then sees high-frequency (blue-shifted) images for another three years. During that time he would see his twin on Earth in the images grow older by  $3 \times 3 = 9$  years. When the interstellar trip is completed, the image of the twin on Earth will seem to have aged by  $1 + 9 = 10$  years.

On the other hand, for nine years the twin back on Earth sees slow (red-shifted) images of the spacecraft twin, during which time the spacecraft twin ages in the images by  $9/3 = 3$  years. The twin on Earth then sees fast (blue-shifted) images for the remaining one year until the spacecraft returns. In the fast images the spacecraft twin

---

40

Miller, Arthur I. (1981). "Albert Einstein's Special Theory of Relativity: Emergence (1905) and Early Interpretation (1905–1911)." SOURCE?

ages by  $1 \times 3 = 3$  years. The total aging of the spacecraft twin in the images received by Earth is  $3 + 3 = 6$  years, so the spacecraft twin returns a bit younger.

To avoid misunderstanding, note the difference between what each twin actually sees versus what he actually calculates. Each sees an image of his twin that he knows originated at an earlier time and that he knows is Doppler-shifted. He does not take the elapsed time in the image as the age of his twin now. If he wants to estimate when his twin was the age shown in the image, he has to determine how far away his twin was when the signal was emitted. In other words, he has to consider simultaneity for a distant event. If he wants to calculate how fast his twin was aging when the image was transmitted, he tweaks for the Doppler shift.<sup>41</sup>

### Time Dilation and Communications with Earth

In theory, time dilation will also affect scheduled meetings between the crew on an interstellar mission and the mission managers back on Earth. For example, the crew would have to set their clocks to count the precise number of years time has passed for them, whereas mission control back on Earth would need to count several years more to allow for time dilation. At the velocities currently possible, however, time dilation is too trivial to be a factor in communications between the ISS and Earth.

### Implications for Interstellar Travel

Time dilation will have huge implications for  $\Leftrightarrow$  crew of a spacecraft and mission managers back on Earth. We must consider, for example, the age of the mission managers for the crew returning to Earth (or for alleged extraterrestrials returning to their home planets) and whether or not an interstellar mission would be sociologically accepted. Consider, for example, a spacecraft traveling at 99% of the speed of light to the center of the Milky Way. If everything goes right, the crew would have aged about 21 years.

---

41

Wheeler, J.; and Taylor, E. (1992). *Spacetime Physics*. 2nd ed. New York: W. H. Freeman.

However, back on Earth over 50,000 years would have passed (as observed from Earth).<sup>42</sup> Obviously all those involved in the initial planning of the mission, as well as generations thereafter, would have died long ago..

## **Applied scenarios:**

### Conclusions

An erosion of Newton's assertion that a unison embodiment in entirety cannot attain any velocity<sup>43</sup> without expelling matter in turn weakens the classical assertion that the universe is "at rest" with reference to the center of the D4 as the bodies center considering reference to space-time in a arguable infinite expanse of D4 which has no center but rather bandwidths considered time in D4 or :P existence; allowing for infinity distance in all directions; the existence of other distinct body systems "universes" where space is under stress in the dimension qualifies as a lesser or greater distance for the dimension bringing to bear the open ended notion of; is a body independent through ownership of space from this universe by it being of this dimension considerable as this universe ? Considerably this may qualify the debatability of the depiction of time distension as illustrated by relativity in special and general theory however planar stress can accomplish this..

This is observed by relativity's assertion that velocity denotes a character of mass where previously it is put forward that rather velocity is functioned by acceleration and denoted as a decay of surface time depth to the negative in D4 and the present.

### Logistics ETA query challenge

A spacecraft leaves earth traveling at light speed LS 1 with a destination 4.5 light years away. At midway dell the spacecraft is traveling at earth light speed LS

---

1 in its

<sup>42</sup>

Interstellar Travel Calculator.

<http://spacetravel.nathangeffen.webfactional.com/spacetravel.php>

<sup>43</sup>

Newton, Isaac, "Mathematical Principles of Natural Philosophy", 1729 English translation based on 3rd Latin edition (1726)

locality with a time differential to earth in factor. This results that a  $\delta t^1$  value is required to know the earth velocity resulting  $V^e/M^0$  of the space craft in kilometers per hour and report distance covered per hour for ground control in order to give an accurate ETA assuming destination distance requiring  $\delta t^2$  value for current observed distances. A

velocity subspace hypothetical counters deep space clocking immersion (reduced presence) where the vessel being below time a physical chromatic tangent resulting from velocity counters the absence of gravity with velocity  $\delta t^3$  which is  $\rightarrow$  exponential commensurate of (g) as illustrated by GPS temporal data . Using these adjustments, time

dilation and related aspects can be reduced eventually to a summary of earth velocity for the vessel which can then be regarded as a yardstick measure in conjunction with a present value ratio of temporal standard for transit. What is apparent are distances are given in light years by an earlier consensus of global intelligent communities; thought to be a physical constant, this is a very serious challenge for logistics where for a star we can note that on taking the center of the earth as point location and judging a stars coordinate position in the sky, that  $\therefore$  of gravity well properties, the position you can perceive is of deviant angles. It has been shown; digress in propagation of time with gravity and that bears on distance covered by light from one gravity well to another where in deep space- time propagates faster and at an accelerated clock rate from your vantage, external to you is a slower clock rate. It has been shown that temperature and possibly subatomic potential saturation in  $fx$  of propagation bears directly on propagation of time and light speed. With these arguments when required for purpose of logistics to give an ETA for a vessel to an interstellar destination, having all information currently available, that errors persisting prohibit this. It would seem that the speed of light increases with increased dimensional stress and time slows down. This along with environmental phenomena like  $\Phi$  foam and medium harmonics plus temperature in variable makes me shy to give you an ETA for Centauri B using inertial propellers.

#### Common scenarios for space travel logistics and debris defense ....

1. Vessels equipped with whipple shields for unnatural velocities would also need extra shielding for ultra high velocity transits.

- It seems an idea that a vehicle having attained terminal velocity luminal even superluminal velocity can release a gas sphere alt dry ice in which it is enveloped, possibly ahead of the vehicle, to act as a transit shield for duration of voyage to near  $\vee$  far systems avoiding potential collisions with micro bodies which may  $\vee$  may  $\rightarrow$  present past the Oort field and Allen / Kuipers belts. This presents itself as a basic maneuver with acceleration to an integral of light speed stop accelerating; the vehicle associative mass is at rest. Release herein example a boron cloud and position the vehicle behind it during transit.
2. A near earth object asteroid type celestial is calculated to be 2 AU and approaching with considerable mass  $M_o$  at 75,000 mph to juxtapose impact earth in a critical condition.
    - Launch a Euro fighter type vehicle to observe and confirm calculation and log relay observations to JAXA, Houston Centrum, Star City and ISS for analysis where on confirmation with accordance a d'Assult type equipped with alternatives Cruise / MX / Exocet and Tipo DF-41 tooled for scaled burst disturbance of space-time locality causing compressions  $\vee$  decompressions of space time fabric with mass energy presence at  $X/Z 360^0$  of NEO to change the objects trajectory path.
  3. Faster than light vehicle impact.
    - Vehicle impact on earth is traveling with passenger to it's destination workplace and is impacted by a oncoming extraterrestrial utility vehicle traveling at  $1s^+$  greater than FTL critical velocity should result in gel fusion at earth geocentric core at

dissolution is my drawn conclusion. The earth vehicle would have a very difficult task to note this occurrence in space-time manifested as neutrino and black body activity. Please refer to "quantum chromo-dynamic transition" description of argument which supports this argument; reasoned sense for travel would be to set travel safe destinations to left or right of plot destination and flight paths attempting also to avoid emergence with previously discussed Planck physical reality of gas and Neptune type celestials.

- Merge for result.
4. Deep Space Dissolution - DSD - Exhibit Oort cloud materials



Gravity well

- A deep space environment is potentially a hazard cautionary for any vehicle due to absence of gravity well quality. In absence of an gravity well matter exceeds a time property resulting insufficient  $\cong$  differential and causing dissolution in structural. A potential causality for decaying value in reference  $h$  at  $s^4 x^+$ ,  $x^-$  with distance from gravity well; adherence for which theoretic postulation without evidence of scientific observation refer: Max Planck Institution – 1948. Space-time ceases  $\exists$  in absence of supporting velocities.
- An approach to solving this is temporal shielding using electro and di-pole property  $\Phi$  pole creating  $\Leftrightarrow$  as static fields with roll cage designs employing vehicle as  $s^2$  frame lift for static and time reference replacing gravity well quality acting as an insulator. Static fields sharing a zero frame reference location separate mono dimensional distance for conjunction displacing  $s^2$  for a vessel perpendicular of acceleration using one pole with an energy time quality supporting complex geometry reference suited to support an evolved spatial improving property of a closed system for a span.

- An approach to solving for bone loss medical using di-electric and di-magnetic shielding creating  $\Leftrightarrow$  as insulator shielding vehicle mass static and time reference replacing gravity well quality acting as insulate support. Static field sharing a  $s^2$  reference location separate mono dimensional distance for conjunction displacing  $s^2$  for the vessel with energy time quality of complex geometry suited to support evolved spatial referencing. Temporal shielding employs a single beam with orientation perpendicular to direction of planar acceleration – Şumbria region offering improved support of  $s^2$  recess  $\forall$  via  $\Phi$  and gradient electrostatic field.

#### 5. R&D of asteroid unknown statics with earth's unknown statics

- Applied – One can employ static shielding to complement temporal modulation for spatial aberration reference in solution to observations e.g. bone loss associated with extended stays in space i.e. ISS long duration astronaut stays. Statics shielding adding to D4 spatial integrals lends to dissolution shielding at complex space-times with resolute in factor of 38 microseconds scale span. At present we quote two identified employable statics, electro and  $\Phi$  which are in vectored temporal reference of systemic displacement and  $h$  Planck spatial. One can make note areas of potential third complementing statics yet unnamed with unknown methods of mechanical harness appearing with response to harmonics, resonance and highlighted by non sciences dousing along with fringe sciences like communion, telekinesis etc phenomenon unexplored for leads behaving as a static fields including stator contenders.
- The inference and ethical implication in our system of this theoretical is to be advised of what is conceivable and a possibility that at an associative dimensional level planet celestials like Saturn and some comets could in their own frame of Planck baud spatial resonance be physical bodies like our own from what one can



Anoxic event ' . Planck scalar perturbation of incubation allowed in roll dimensional scales of  $-r$  accounts for polarization of microwave background including precursor exhibiting global phase transit. Topological obstruction with field gradient that corresponds gradients in two quantities for vacuum expectation for frame model horizon with flat spectrum in key quantities observable for generic trashing at 10- 500 sample of singularity in entropic.

- An approach to solution for Helium transfer lunar .. geo is probability constrained with complexities of temporal. Lunar burn prediction frame model is complicated and follows for scenario temporal lunar at  $t^{-1}$  for burn  $t^0$  delta  $\Delta$  epsilon in C propagation transit with loss in temporal resolution in G gradient  $\Delta$  for a cohesive differential in approach transfer of Helium borne via solar wind. Yield  $\angle$  in net for t fx
  - $V^C \Delta V^G$  lunar..geo is failure unknown. One then begins to assign temporal values respective one another  $\bar{t}$  geo with  $t^+$  lunar to quantize a  $\nabla$ . From a geo vantage lunar atmosphere winds and so on appear nonexistent however further evidence points a valid postulation of surfacing ignition for observation. From temporal  $\nabla$  -  $t..t^+$  combustion of  $\bar{t}$  materials at vantage  $t^+$  a combust is of nuclear quality whereas from vantage  $\bar{t}$  a combust of  $t^+$  has a radio quality

"At sunrise and sunset many Apollo crews saw glows and light rays. This Apollo 17 sketch depicts the mysterious twilight rays."<sup>44</sup>

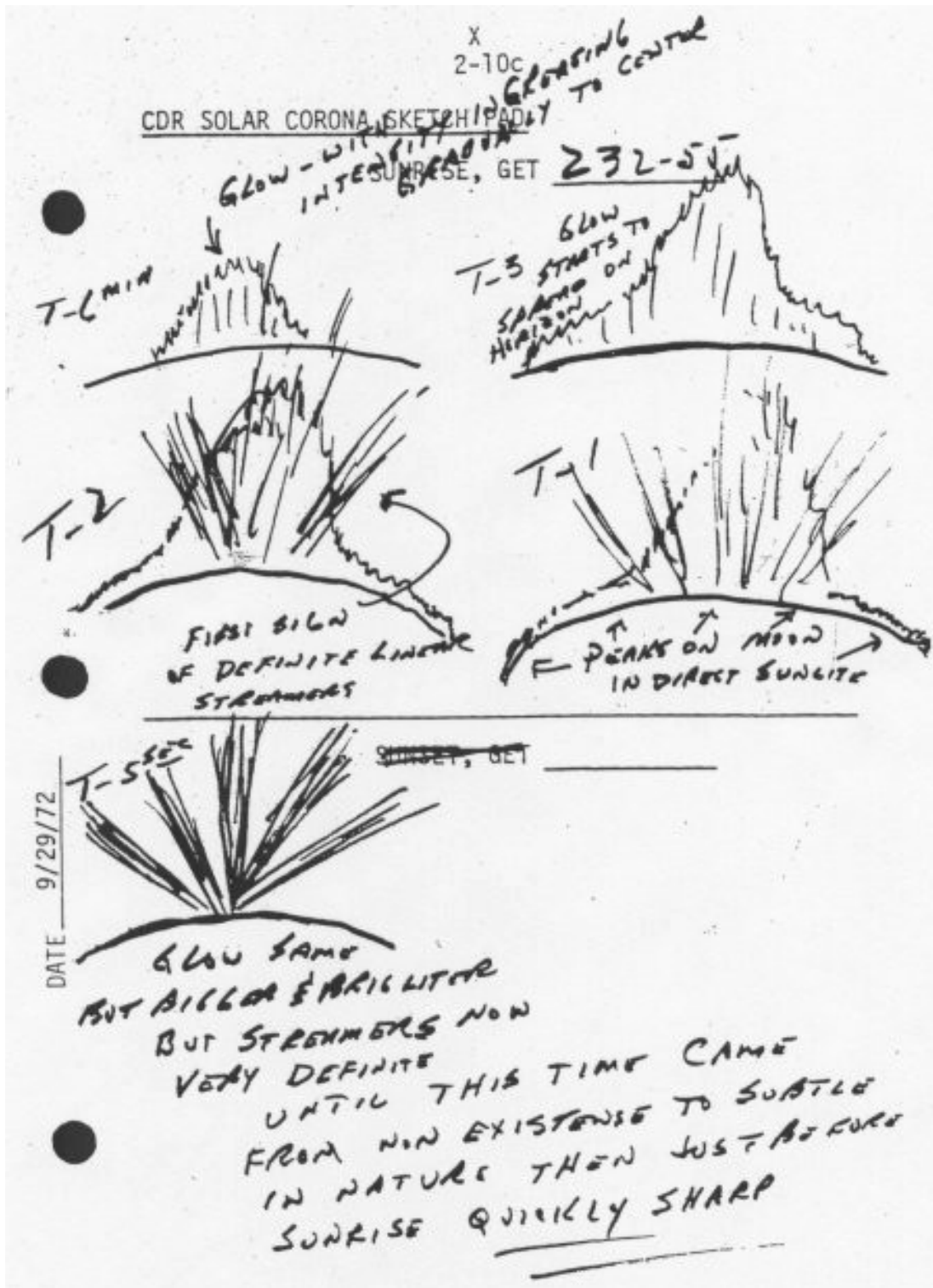

- Currently there are several agencies that can provide guidelines for lunar access along with onboard counter measures there is a possibility to provide rapid response.
- Please refer NASA Glenn, JPL, Star City, JAXA and IRF for anoxic burn scenario prognosis. Consider scenarios with extreme caution where in example considering moving fusion fission domestic energy production off world.<sup>45</sup>

## 7. Abyss Paradox

- The vehicle is travelling with ultra high speed and acceleration to where all variables of common space are contorted in a complex state towards a space time door.
- A vehicle is suspended at a free fall dimensional time depth without reference to common velocities and this is a directional conundrum of dimensionality.
- Decelerate to neutral reference point to point of velocities attempting to reset a vessels space-time temporal locality atomic indexing of void through compression decompression for your vehicles space-time variables using quantum chromo- dynamic transition indicators including red shift and any available reference with an energy requirement.

8. Latinum gold shire apocalypse

- Asteroids as big as 2 kilometers can discharge an impact energy of a million megatons and create an effect similar to a nuclear winter, with loss of crops worldwide and subsequent starvation and disease. Still larger impacts can cause mass extinctions, like the one that ended the age of the dinosaurs 65 million years ago (15 km diameter and about 100 million megatons).
- Please refer NASA Glenn, JPL, Star City, JAXA and IRF for impact scenario prognosis.
- Regulatory bodies traffic control authority of asteroid proximity and mass value as an approach for permit issues.

9. Rhea aesthetic - Near earth objects infrastructure accumulation with space debris liability of energy propagation with an extended sphere.

- An extended sphere from system center of mass imposes propagation a dynamic of arc bridging near earth objects infrastructure with reference electric potential of the earth's surface. Bridging juxtaposition for plane of centrifugal acceleration creates arc bridges for energy lazing ad-hoc h inertial planes.

10. Vehicle dynamic of deceleration employing an inertial propeller method of propulsion with singular  $s^2$  reference creates condition for  $\cong$  contrasting D4 in far region to import foreign dimension material with  $\cong$  of  $\theta$  contrasting D4 for nova solar.

- Lacking accumulation of data on this scenario postulates  $\cong$  with  $s^2$  for foreign induction of adjunct dimension to plane of reference for solar nova in positive plane  $s^2$  at extreme employ suggests prudential usage of related tier technology inertial frame presented here for interstellar where propulsive  $s^2$  is shared as  $s^2$  plural  $s^2$  propulsive reference. Another approach is non native, having evidenced defect, divot deceleration consideration along with generous tolerance levels embedded with infinity drive allowance routines. Note: postulation  $\rightarrow$  self regulated disambiguation  $\theta$  generation destroying this modeled incumbent propulsion drive.

## Appendix:

---

By all herein matrix of debate and arguments presented here is analysis of interacting movement and existence in relation to time. It remains yet to identify a doorway linear or otherwise logical path which would lead to the suggestion of travel or gravitation along a mental construct dimension of time described by hours, minutes and seconds :P which separates from existence being time and residing undetached from the present of float at impasse zenith in tangency. With our universe represented physically in a dimensional plane populated D4 being a divide; the postulation of D4 physical reality does allow for the existence of alternate universe realities existing at alternative spectrums of  $\cong$  separated by unison velocities as distinct from our universe however travel to which does not indicate travel along any notion of a timeline rather describable simply as other dimension property possibly occupying frustums or subsections a same location but not relating and interacting with one another physically separated by unexpressed velocities and hence dimensional time depth.

With reference to common space directional velocity can only represent itself with a null value expressing chromo-dynamic shift and this as relating to an infinite expanse D4; velocity expresses itself as in all directions simultaneously. Conceivable as one considers that when traveling away from a point in space at a hundred meters per second one can maintain that velocity to travel at the same speed going through a half circle turn and still be traveling at the same hundred meters per second now towards the same point in space hence directional velocity is a null quality exerted in all directions and time expressed functionally; with reference argument that a loop back is time decayed as an acceleration event; at no point is the vehicle's velocity slowed, which brings into question the possibility of covering distance in a sub space hypothetical an alter dimension and relevance of direction. Going through a half circle consumes a sum of energy to effect the change and the energy value of directional velocity is decayed mathematically to zero referencing the unison body at 90° of the turn while retaining the same level of directional velocity energy at the midpoint of the half turn. In orbital disjunction and inertial frame propulsion, space-time track parse affects deformation of space time gradient facilitating propulsion.

From dialog - all above - the focus here seems to be that at this location space-time conventional theory contends that a vehicle may encounter a time floor equivalent of chromatic increasing mass argument to the big bang at a given velocity putting it at seven and a half minutes below time in this location and surface through time referenced at location. Using arguments presented here this event is described by where a gravity signature of a structure either contracts or expands to a state where a structure referencing it becomes unstable since it's signature ceases to reference a stable value from CG of this planar universe in abstract. Seems within reason to suggest an opinion that this nova would not have expected vibrancy, be of a filtered spectrum less the 99.9999% vibrancy yield in designed surface novas. This is

perhaps a useful argument to consider should one want to plot course heading for a different system with the view that to accelerate a terra tonne vehicle at 25 gravities for a period of 31 days approximately may not in argument equate to a critical elastic tolerance breach of common space allowing fluid time linear pivot dimensionality since light speed is a natural velocity. Having postulated this advocate along with complex structure ownership of space and reference , it seems to me obvious that from in the vehicle, one would get indications of disposition from diagnostics. Such an indicator would be for example a resulting artificial gravity in the vehicle from  $\cong$  of an elasticity free space boundary. There is a possibility of noted and plausible dj encore and dj quicksilver below  $s^2$  argument that could result in a stasis suspension, a difference of dissolution and instance accumulation for translocation.

Theoretical by: [www.shwaycoms.com](http://www.shwaycoms.com)

Stefan Yankeneh Alexander Tubman - Logistics

2014 Asc. Ba. Esq. Concluded:



- a. matter :P perception is CG an introspective and is  $s^4$
- b. temporal propagation is determined by distance<sup>46</sup> from  $s^2$
- c. super luminal transport associations of latency with temporal dilation is gravity well symptomatic - Special Relativity retort.

Credits :

- My parents Nature and nurture
- Isaac Newton Principles
- Lorentzian Special relativity dialog
- Stephen Hawking Tutelage
- Lene Hau Vastergaard Observations
- Rymdforum IRF Observations
- Bo Göransson Observations
- Glenn Research Center Observations

Table : Symbol Key

SI = Quanta space

-sin = Gain

$s^2$  = Space-time zero nonexistence is null C

$\Sigma$  = Sum

$f_x$  = At a function

$\cong$  = Dimensional stress

$U\cong$  = Universal Dimensional stress

$\omega$  = Angular velocity

$h$  = Plancks constant

$\theta$  = Fluidity  $\cong$  is expressed by angle of rotation

$\wp$  = opposition

$\wp$  = conjunction

External derivative : Starship Congress 2013

<http://www.icarusinterstellar.org/congress-livestream/>

Dell divergence equivalent = Green function calculation differential equations<sup>47</sup> ▽

Light cone  $\cong s^2$

(x) Equinox Stop Light North +/- Static

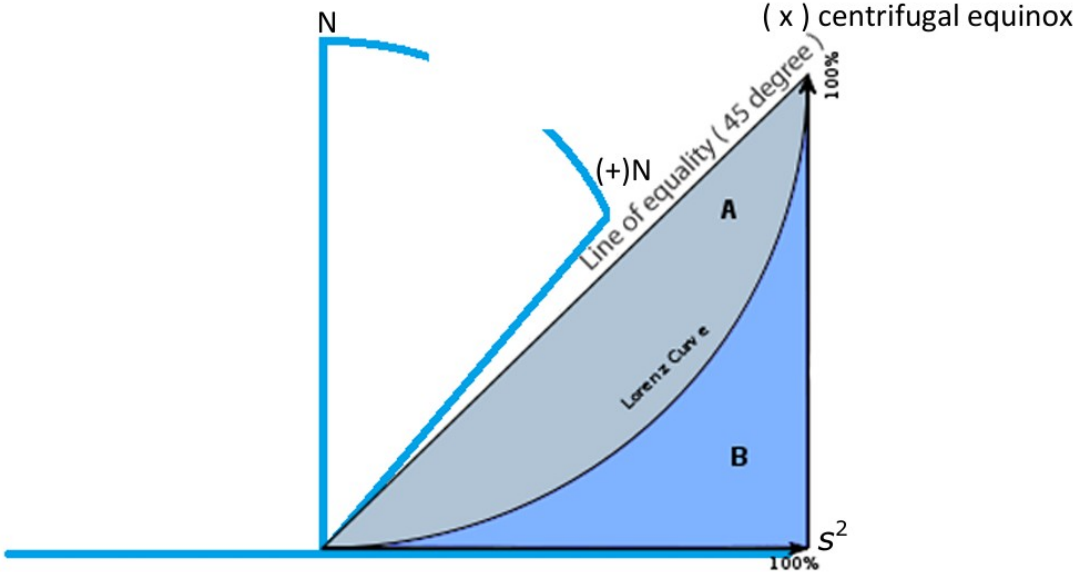

<sup>47</sup> Ralph Ewig, PhD - VP of Engineering at

Aerojet  
Sacramento, California Area Aviation & Aerospace 2012

Key note : Lene Vestergaard Hau

Lene Hau's condensate is a ground state optical super conductor referencing a ground state medium bose Einstien where wave form can exist less time  $\cong$  with harmonics choosing to own equilibrium continuum referencing its own rate of change which is static between equinox and zenith verso  $U \cong$ . We postulate that this medium presents void property as SI of  $s^2$  distinct from D4 governed by CG in spectrum. Lene presents this in reference to spin alignment from which one can mate that placid spin alignment presents medium aligned clock points; gravity without latency, mechanical and  $fx$  of a temporal, distance from gravity signature compounded with verse in plural yet singular for wave forms to present extended least distance at a planar scale. Wave form packet metrics being identical in conclusion for long and short waves for which a character allowance is a temporal attribute of space-time where long waves presents a property of an event persisting when compared with short wave forms. A local variable attribute  $\therefore$  space-times ad infinite in reference of complex spatial singularities remain at rest for example by locality propagation to maintain consistency with  $U \cong$  at least potential exhibited by radii property shifts including transference.

Implications of these breakthroughs: that this research can progress to breakthroughs in energy storage perhaps 802.11<sup>48</sup> for steam. Releasing energy from a condensate battery in a consistent and a convenient method would be  $\Phi$  field lift in medium for duration (alt lift field) extending wave form distance from equinox (zenith) by displacement (sine wave perspective). On refinement, adaptable, energy storage fuel cells can be developed that store wave form energy at next to no weight cost and capable of phenomenal density to a cell for vehicles. An added advantage of this technology is charge flexibility for vehicles where ground to space and vehicle to vehicle refueling becomes possible. On inquiry this was rejected by Hau in favor of information storage a more delicate treatment of radiance properties.

---

48

802.11-n is an inadequate title for PAN radio  
 Personal Area Network devices also PNR – Personal Network Radio. EIEEE review.

## Key note speaker : Dr. Michael Minovitch

### Comments

Hoop values for elevator core scoop evaluation presented on www is a assessment calculation based on available wiki 2010 material reflecting a difference of 100:80 repelling fields of same pole di-poles 100:100 where  $1N \neq 1N$  for attraction quality in Gauss law of opposite poles. Values given for elevator core estimates are based on a negligible divergence gradient of our geo  $\Phi$  field due to the size difference of opposing  $\Phi$  dipoles and a constant geo  $\Phi$  field for distance.

### Core construct approach suggestion:

Di-pole support structure is less cumbersome in OA's<sup>49</sup> release calling for a plasma conduit between coil skins original tokamak than with an alternative design calling for conductive gas coils/cylinders<sup>50</sup> in a proposed di-pole reactor vessel where increased weight is balanced with improving an elevator cores  $\Phi$  property. Conductive gas is introduced as medium to induction of a electro- $\Phi$  static field for wraps not requiring cooling. High voltage fine filament routing coils  $< 0,2mm$  supported to a (+/-) vertical divide in a core's chamber where filament temperature matches impedance resistance of gasses; a suitable light weight tokamak solution using conductive gas that can be a cooling medium.

## For Magnetic Elevator

---

Conductive ionized gas solenoid design:

Another solenoid design is a ionized conductive gas aerospace solenoid resulting in a lightweight suitable core for a magnetic elevator core increasing design weight while lowering performance stress for a field generator. The solenoid is sheathed with an outer skin as for example a gas filled filament light bulb and as with some incandescent light bulbs one can employ thin filament wire being of insignificant mass weight being so thin very little metal is used. The tokamak ionizing chamber is filled with a conductive gas which has a higher resistance property than the cores fine filament coils wound as with a conventional solenoid however spacing from one coil to another coil of filament can be on a filament rack constructed of fine wire.

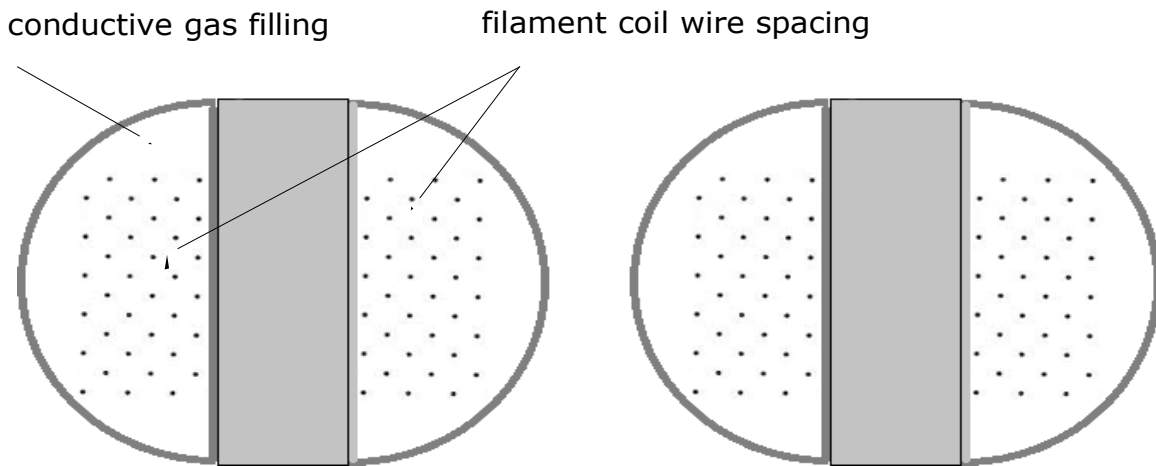

in this design the change in ohmic value as a function of temperature in the filament results that the conductive surface for energy charge throughput is increased to a field employing the conductive gas allowing higher throughput than is the capacity allowance of the filament wire on its own. As throughput is increased through the filament its ohmic resistance value increases to where it competes with the conductive gas resulting in a zone of conductivity around the filament that acts as a lightweight routing coil filling the cavity body of the tokamak . The property of arcing should in design improve the number of  $\Phi$  wraps available for  $\Phi$  yield as for example a catalyst of this property is introduced being a catalyst is of material conductive property different from employed conductive gas consistently.

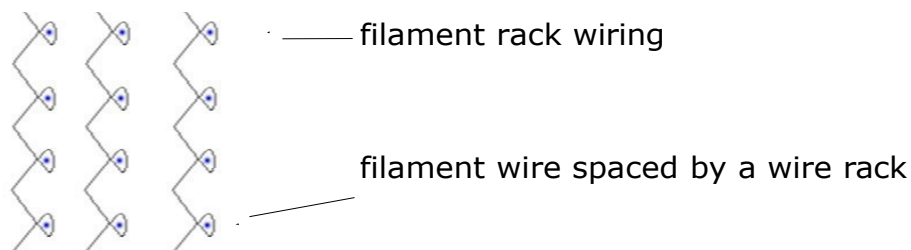

Conductivity and admittance being reciprocals of resistance and impedance respectively, the tokamak's chamber gas mixture functions as a semi-conductor complementing coil filament wire routing.

Key note speaker: Joe Ritter

Comments

Telemetries telemetry etc agreed is a fine way to get to know what is out there and survey what challenges our future has in store; an approach is to monitor from midway, set up and maintain outposts for science and research data collection before attempting initiatives directed at other systems.

Nano arc second imaging may be possible with multiple high frequency processors running out of synchronization processing analogue optical imaging equipment a concept not one familiar to me and likely a concept for supercomputing to improve sample rate fps.

A  $\Phi$  field (pressure) excludes (displaces) electric potential.

An explosion originates at speed of light and propagates at a velocity rate decayed in  $fx$  of occupation of a spherical SI being exponential  $\cong$  enforcing a boundary event for iteration an event transitioning from point of origin to a surface  $h$  value  $h$  for subvention where  $t^{-1} \Rightarrow t^0$  a horizon of  $-\sin$  (for void) - impasse (blizzard for space weather) versus solar flare propagation such like a lightning static sphere implies a time for specific event.

Q. Why does a balloon move forward in an accelerating car?<sup>51</sup>

A.  $\angle$  interactive in an imperfect closed system moves in a forward motion and a downward pressure resulting occupancy of greater space related to confines of a curved space such that the space behind the balloon is less than the space ahead of it – thx a nice puzzle

Local variable map: displacement technologies, *Tesla* sphere displacement subjective of  $\Phi$  repel with temperature allocate as dark matter excess dynamic

accounting for:

$t^0 = \omega \cdot \angle$  velocities<sup>+</sup> of  $U_{\omega}$  in rotation plane systemic centrifugal planes of acceleration.

Systemic geo magneto model

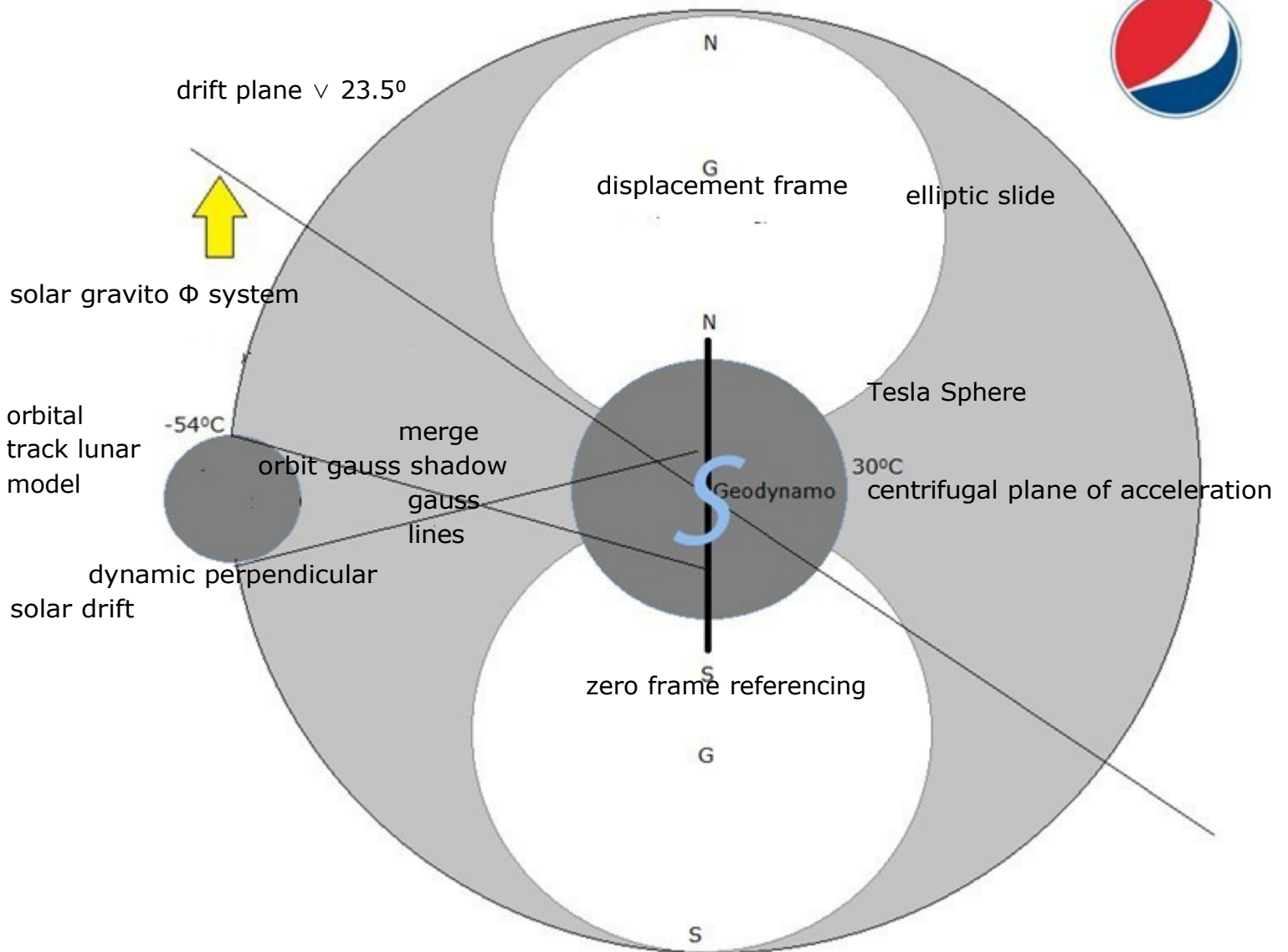

NB: Planar expansion / matter SI dynamic accounting predominantly for celestial rotation along with centrifugal plane of acceleration contagion<sup>52</sup>.

## Lifter Ionocraft

.. With lifters<sup>53</sup> one observes ascent with elevation of a field removed from curved locality; distinct geometric spheres elevating with dynamic of SI distribution, lower and upper volumes displacing one another.

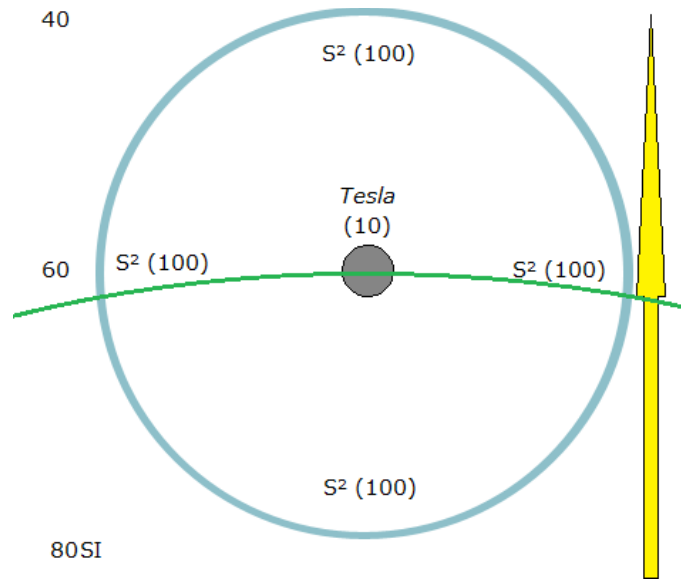

An observation of passive dual pressure shrinking and expanding in dynamic of spatial differential; distinct hemispheres tesla statics being a dimensional displacement of existing fields with conjoined -sin by volume in  $fx$  of field gradient and a zero frame vehicle having aligned fields plus (van de graaf) initial event a static. Ionocraft lift vehicles are potentially capable of lifting lunar mining payloads when factoring increased displacement parameters. Concepts face a challenge of glass ceiling (floor) which can be explored with drones from an insulated pylon pedestal using a microwave fueled static field, Ionocrafts exhibit a sticky tesla field property. In the earth's tesla sphere a greater exclusion of complex space volume is realized with less energy since a  $\Phi$  field displaces an electro one for a complex -sin; this type of vehicle does not ascend by  $fx$  displacement of air complex and comparable results are realized at a different locations.

An observation for this figure can be that  $t$  -sin in this figures upper hemisphere is geometrically  $>$  than  $t$  -sin in it's lower hemisphere which  $\Rightarrow$  that propagation  $\angle t^0$   
..  $\angle t^1$  in it's upper hemisphere is  $> \neq$  temporal propagation in it's lower hemisphere with  $\otimes s^2$  null mass referenced as *Tesla* (10) SI is further from void where  $\cong \uparrow > \downarrow$  in verbose correlations. A lunar gravity sphere presents a spatial property less complex than the earth's due to a smaller size, lack of atmosphere with improved curvature for lifters; it is conceivable that static field separation is a likely force that maintains asteroid fields, preventing their collapse by SI -sin  $\therefore$  ownership  $\Rightarrow$  spheres of influence and contagion.

Keynote : E. E. Podkletnov (Yevgeny)

## **Diametric Propulsion Drive**

[www.shwaycoms.com](http://www.shwaycoms.com)

Patentansökan nr 1400129-1

PRV : Not Submitted as Open Aerospace at [www.open-aerospace.org](http://www.open-aerospace.org)

### Brief :

This document is a description covering an overview of Podkletnov Diametric Propulsion a diametric drive which is a overview of a previously unknown and undocumented functional acceleration manipulation device which is a concept introduced 2014. After reading this document you will basically understand mechanism of how to build a functional modeled propulsion device and have a understanding of functionality. Podkletnov diametric is entirely an innovation invention. This device is a rational functional aerospace propulsion chassis concept which introduces a new innovation in methodology unexpressed prior to this document in 2014. This innovation by assessment of Eugene Podkletnov a colleague from BPPP 2002 theoretical principles and proposals are evaluated over several years to present of his achievements; data was subsequently collected and interpreted. The device is a Podkletnov diametric acceleration device and is a innovation 2014-03-07. Present here is manipulation which covers its capability of acceleration as well as elaborated proposal of use as a propulsion device. This document should be reviewed by a applied physicists and engineers for interpolation assessment.

## Diametric reference

Rotation has the potential to accelerate and given torque / Coreolis / Euler / centripetal / centrifugal force properties the tensile structure of structural composition will use energy to compete for and maximize space available to it at 90 degrees. When spun into a curved space rotation at a high state of torque acceleration the disks will occupy and attempt to own the path of least resistance affording maximum space this is to say that it will occupy with great force the available space at 90 degrees of spin along the equatorial of the axis of a disk component. We can then say that the introduction of a quantum vacuum gradient will cause a quantum vacuum distension gradient in opposition to the 90 degree spin of the axis of the disks causing it to consummate a distension state of acceleration reference facilitating propulsion. The device allows transference from gyroscopic rotation stasis to diametric acceleration at potential between parallel planes of rotation.

configuration of diametric drive for R&D.

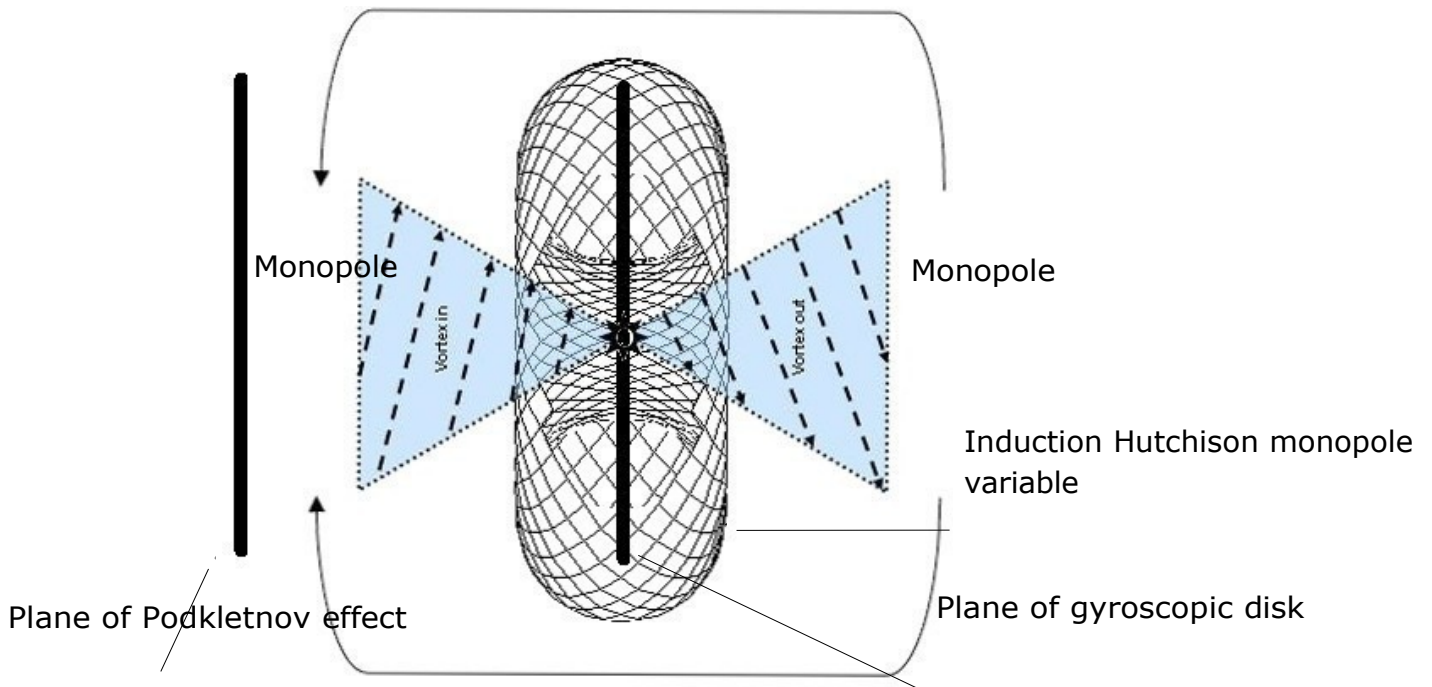

Perspective:

plane of positive reference

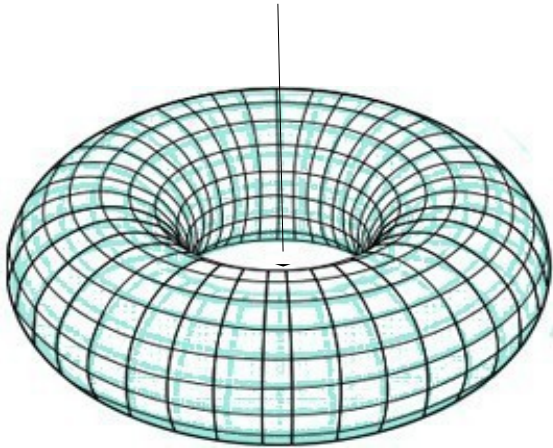

negative reference  
planar floor  $s^2$

This illustration shows a torus form with a gradient reference of  $\mathbb{H}$  that is above  $s^2$ . The torus is inter existence existing above  $s^2$  which requisites a store of values to reflect values of a shape, a dimensional, including planar positive and negative references while exhibiting also gravity of mass at  $s^2$ . It is a torus  $\mathbb{H}$  with reference location of a void at  $s^2$  concurrently propagating in  $\theta$  for a light cone in free space. CG planar from  $s^2$  cannot consume a void reference without physical rendering also propagation at a velocity is an index of  $\text{:P}$  rather than an acceleration  $\nabla$  as with  $\cong$  for example: a parachuted falls such that acceleration is matched by coefficient drag  $\otimes \cong$ . Least distance route factor cannot be rendered with linear  $\rightarrow$  angle a consequent result of  $h$  constraint for  $\exists$  to a location  $\exists @ s^2$  with  $\otimes$  resulting propagation at velocity for finite value in  $fx$   $t$  momenta for which propagation resolves  $\cong$  where  $t^0 \Rightarrow t^1$  for location above  $s^2$ . Plane of positive reference can in this way exhibit a body shape with store of values for  $\Sigma$  of stored values with include of an external velocity value; a juxtaposition of distinct voids, dimensions immiscible as an abstract.

A helium environment would contribute with flux of free space for subatomic potential funnel of a monopole possibly from a static field Hutchison monopole ranging viable potential of void vortices static to disk a length for reversion RF (Podkletnov).

A Hutchison effect shows to displace an object in a gravity field for field aligned orthogonal atoms excited and producing subatomic potential (void potential) which enables the object to compete for ownership of space eventual orbit better while producing void potential along existing field alignment. For this drive to function potential is vortexed to a monopole which is reverted by a Podkletnov plane at one end resulting in a diametric spatial configuration resembling a segment of a gravity well.

A Podkletnov diametric drive resembles spatial distribution of a waveform to facilitate propulsion.

By Stefan Y. A. Tubman

## Aerospace Propulsion - Rebound Propeller

Stefan Helmz Tubman 700811-9278 Propeller configuration PRV Pat.  
0800531-6

Rebound propeller

This is a logistic overview of the configuration and sequencing of a Rebound Propeller. A Rebound Propeller is an aerospace propulsion propeller device with no theoretical limit to the velocity it can achieve for a vehicle. With each cycle of a Rebound propeller a vehicle propels itself to an increased velocity. Acceleration is not constrained to speeds below light speed as with combust dependent propulsion. Rebound propeller iterates with acceleration followed by gain of momentum at a higher velocity preventing deceleration. The Rebound Propeller is composed of two modules a valhalla pendulum module with gravitation rotor shield array.

### Valhalla Pendulum Module

On its own a pendulum array as shown will cause a vehicle chassis to sway back and forth in net zero acceleration.

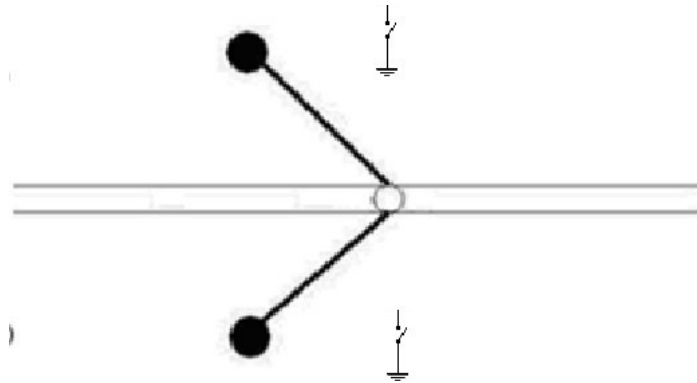

Here above we show a pendulum module with two weighted counter rotating that trigger switching of the overall rebound propeller when traversing equator shown with switch annotations at both sides.

### Gravitation shield rotor array

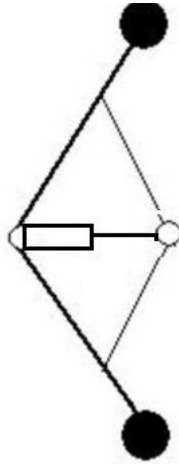

Momentum acceleration shielding is released by a closing or drawing in of the weighted rotor assembly through an acceleration event. The rotor assembly is an assembly of hinged flexible spokes at axis when in mode of Rebound deceleration shield inhibitor functioned by piston with motors spinning the rotor array.

The rotor assembly maintains momentum and velocity functioned by the pendulum assembly when fully extended and is synchronized to the pendulum assembly transitioning from a closed off state when the pendulum assembly counter rotates through its forward hemisphere and the vehicle accelerates forward through pendulum rotation forward of equator switch point. The rotor acceleration shield is functioned with by piston to open and close the rotor shield a logic gate state "on" and logic gate state "off".

11. Rotor assembly with two rotors in an "off" state.

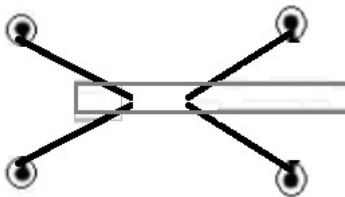

12. Rotor assembly with two rotors spinning fully extended in an "on" state.

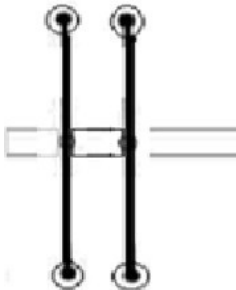

The rotor assembly is extended on allowed to spin freely while flexible and fully extended when the pendulum rotates through its rear of equatorial hemisphere - refer frame 1 below. The rotor assembly functions as a gate to allow forward acceleration refer frame 2 and deny deceleration transitioning through "on" and "off" states.

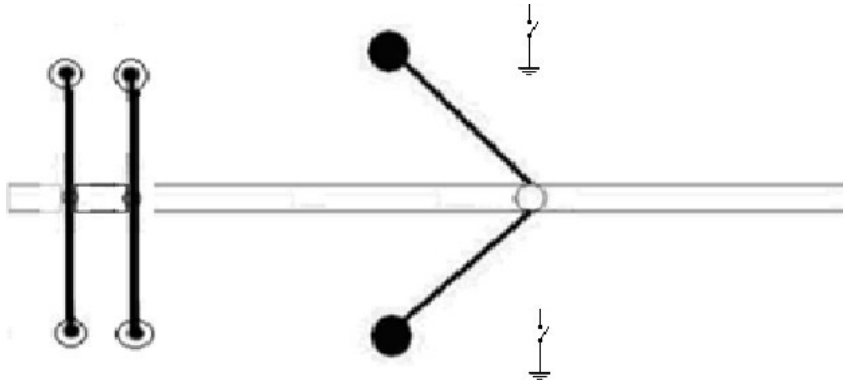

Model A. Frame 1

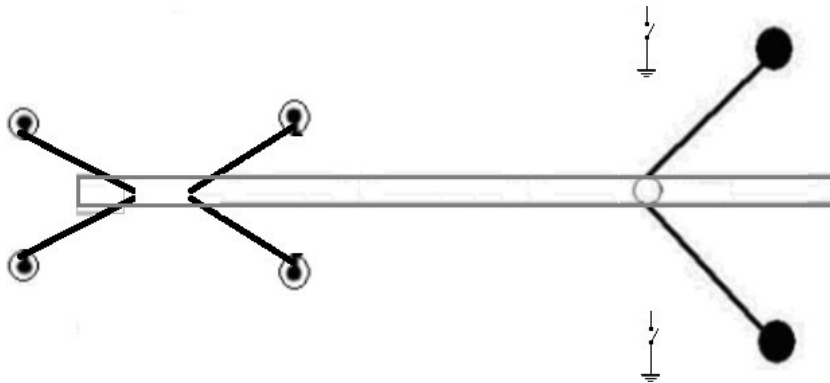

Model A. Frame 2

The rotor array is switched to an on state at equator transition of the pendulum assembly throughout rear of equator switch hemisphere. The rotor assembly acceleration shield is switched to an "off" state while the synchronous counter rotating pendulum assembly goes through the forward post equator hemisphere.

Rebound propeller affords two modes of propagation accelerate and over drive. For acceleration mode the rotor assembly is switched synchronous to the pendulums transition of equator and over drive is a function of rotor state switch at the pendulums transition of forward and rear equinox.

Rebound propeller is suitable for an aerospace magnetic crane mounted to an air frame for 10m at 10.000hp via a harness or 2m for standard airframes. Alternatively multiple propeller clusters can be synchronized to function in tandem or as single unit.

Rebound propeller is so named for undulating valhalla pendulums of shuttle relative mass rebounding off of a logic gate acceleration shield array.

Engineering issues.

The rotor assembly here is depicted with assembly to deflect the rotor assembly to an "off" state this on of switching can be practically achieved with a piston assembly synchronized to the pendulum rotation respective equatorial with reference the chassis and rotor assembly. Performance of the acceleration shield rotor assembly can be adjusted by maintaining a constant rate of rotation via gearing in open closed states "on" and "off" for the rotor assembly. This is left to the discretion of the builder when trying to improve a build.

Rebound motor adjuster motor another rebound form factor. Algorithm for Rebound

motor

Close Attract Open Repel

A Rebound adjuster motor operates in four strokes.

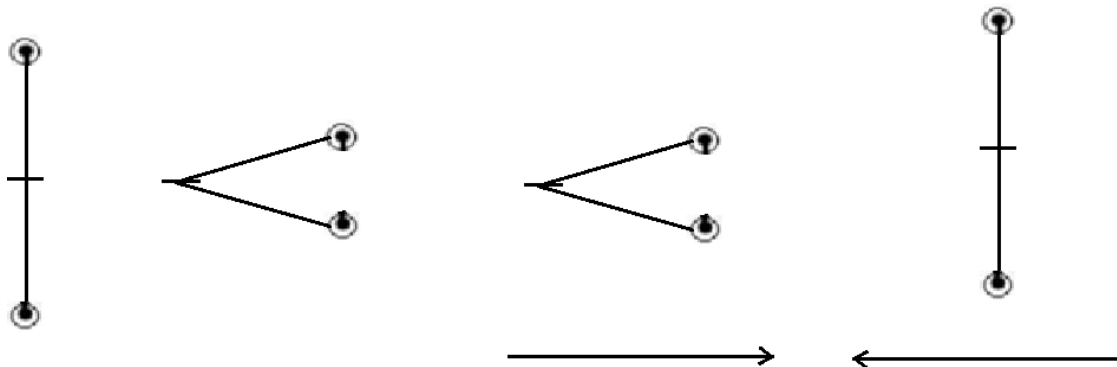

Alternative configuration for rebound propeller. Model B. Frame 1

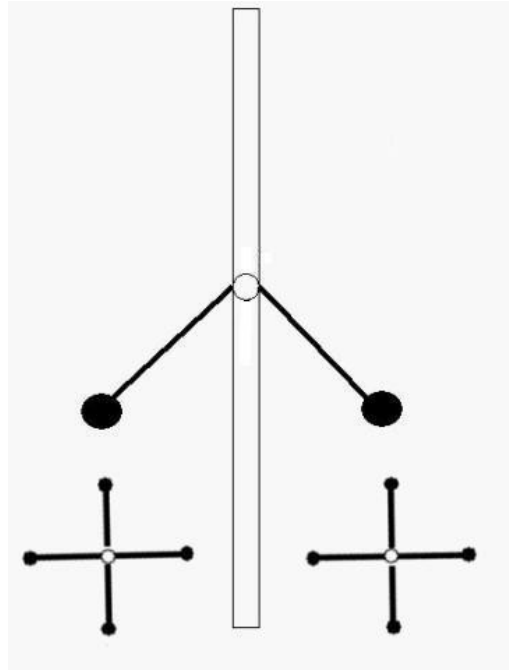

Here we see that this propeller's rotor shield array is configured in a horizontal position versus vertical as with model A where above we see the propeller in a rotor "on" state acting as an accelerator shield array to absorb reverse acceleration propagated by it's valhalla pendulum array.

Model B. Frame 2

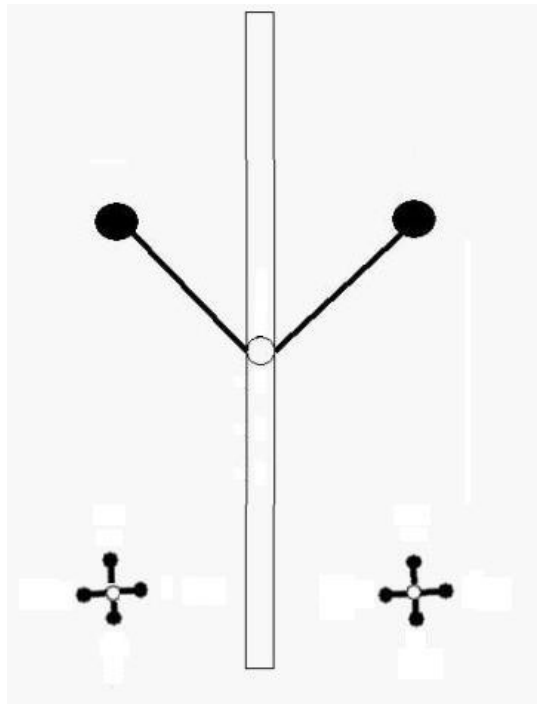

In this rotor "off" state the vehicle accelerates forward with as it's valhalla pendulums rotate though forward of equator hemisphere for reciprocating propulsion. All modules pendulum and rotor array are on the same chassis frame not showing a cross bar in Model B. illustration

Prototype rotor acceleration shield:



### **Description**

Rebound propulsion is a new method of propulsion for vehicles aerospace requiring propulsion in free space.

That which is unique to Rebound Propulsion is that one circumvents a traditional separation of ejection mass (fuel) for propulsion in air and spacecraft. In this it can be describe as a closed system propulsion enabling dis association of explosive mass impart limitation of light speed.

## **Rebound propeller patent specification**

Rebound propeller propulsion is a new method form of propulsion for vehicles aerospace requiring propellantless non ejection form of propulsion.

Rebound propulsion utilizes weight displacement to manipulate the center of mass of a vehicle in closed algorithm allowing controlled acceleration propulsion without imparting mass from a vehicle for aerospace propulsion.

The concepts integral argument is to use relative mass manipulation vis the vehicles center of mass hitherto deemed nonconventional property of motion.

## **Centripetal Propeller - Orbital Propeller - Infinity Propeller - Propulsion**

[www.shwaycoms.com](http://www.shwaycoms.com)

Swedish filing reference: Stefan Tubman 700811-9278 PRV# 1800145-3

### **Brief :**

This document is a patent application and covers an overview of Infinity Propeller which is an overview of a previously unknown and undocumented functional acceleration manipulation device which is a new concept. After reading this document you will basically understand mechanism of how to build a functional modeled propulsion device and have a understanding of functionality. Centripetal Propeller is entirely an innovation invention.

This device is a rational functional aerospace propulsion chassis concept which introduces a new innovation in methodology unexpressed prior to this application to the Swedish patent authority body PRV. This innovation is not a gift or token purchase; nor collaboration from any collective with which I have collaborated; data was subsequently collected and interpreted. The resulting device is an electromagnetic enhanced acceleration manipulation device and is a new innovation. I present here manipulation which covers its capability in manipulation of acceleration as well as elaborated proposal of use as a motorized propulsion device. This document should be reviewed by a qualified applied physicist or engineer for interpolation assessment.

### Prototype example §



In the photo picture of mono model above you will find that this idea is to build an acceleration propulsion gyro disk inducer pair similar in construct to the lab model in the picture above. The drive for this exhibit is two meters in diameter weighing forty kilos with twenty spokes per gyroscope element. The result is an acceleration device with a rotation disk weighted at outer edge with shuttle mass a kilogram each having a magnetic  $\Phi$  polar positive property at bottom of the weights for repelling by magnetic force from below.

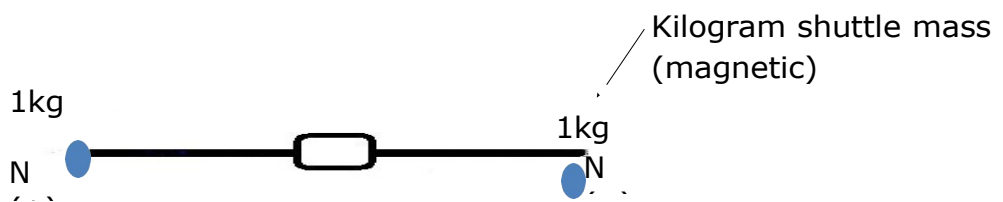

### Propulsion disk chassis

A dual direction Centripetal Propeller is stressed by placing a repelling force magnetic field below and above dual propulsion gyros covering a quarter hemisphere of the device deflecting it apart in a quarter hemisphere to induce acceleration by momentum transition to the vehicle chassis frame in orientation; here it is quarter  $180^\circ$  to  $270^\circ$  for the upper propulsion gyro. Aft and Bow refer to rear and front of the chassis frame shown here in vertical cross section for reference in orientation of

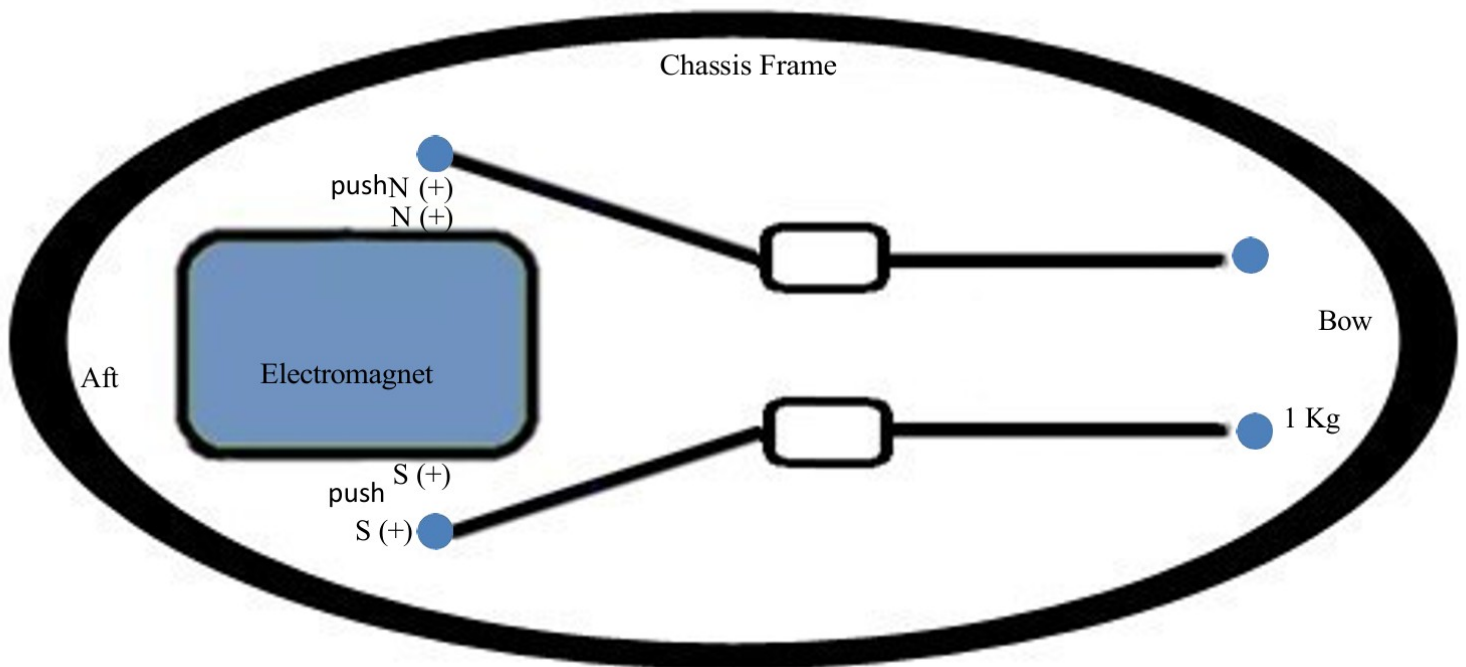

vehicle direction.

The electromagnet (magnetic) component deflects the shuttle mass with lift and release of the flexible spokes at  $270^\circ$  to  $180^\circ$  on the Aft side. On release the shuttle mass flattens out over quarter  $180^\circ$  to  $90^\circ$  where the upper propulsion gyro shuttle mass is spinning anticlockwise for this exhibit. The lower propulsion gyro is the reverse where shuttle mass spins counter to the upper so clockwise in exhibit and is deflected magnetically from  $90^\circ$  to  $180^\circ$ .

**Horizontal view shuttle mass quarterly reference:**

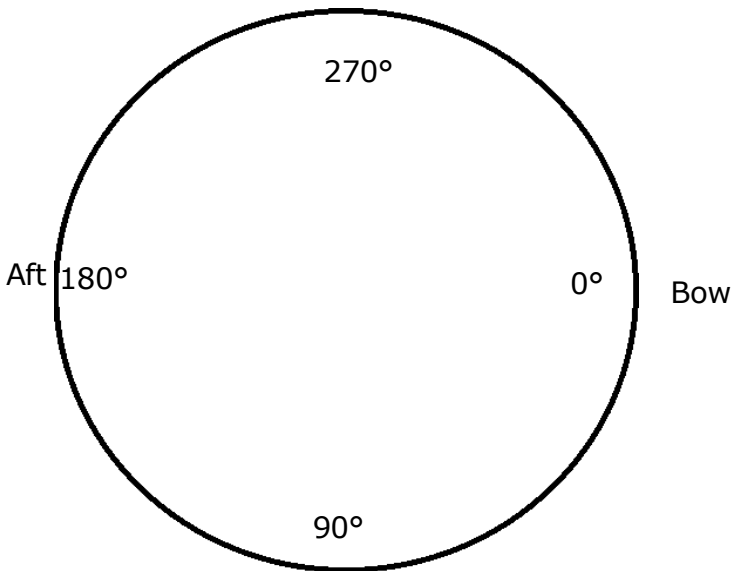

**Overview upper shuttle mass horizontal cross section view :**

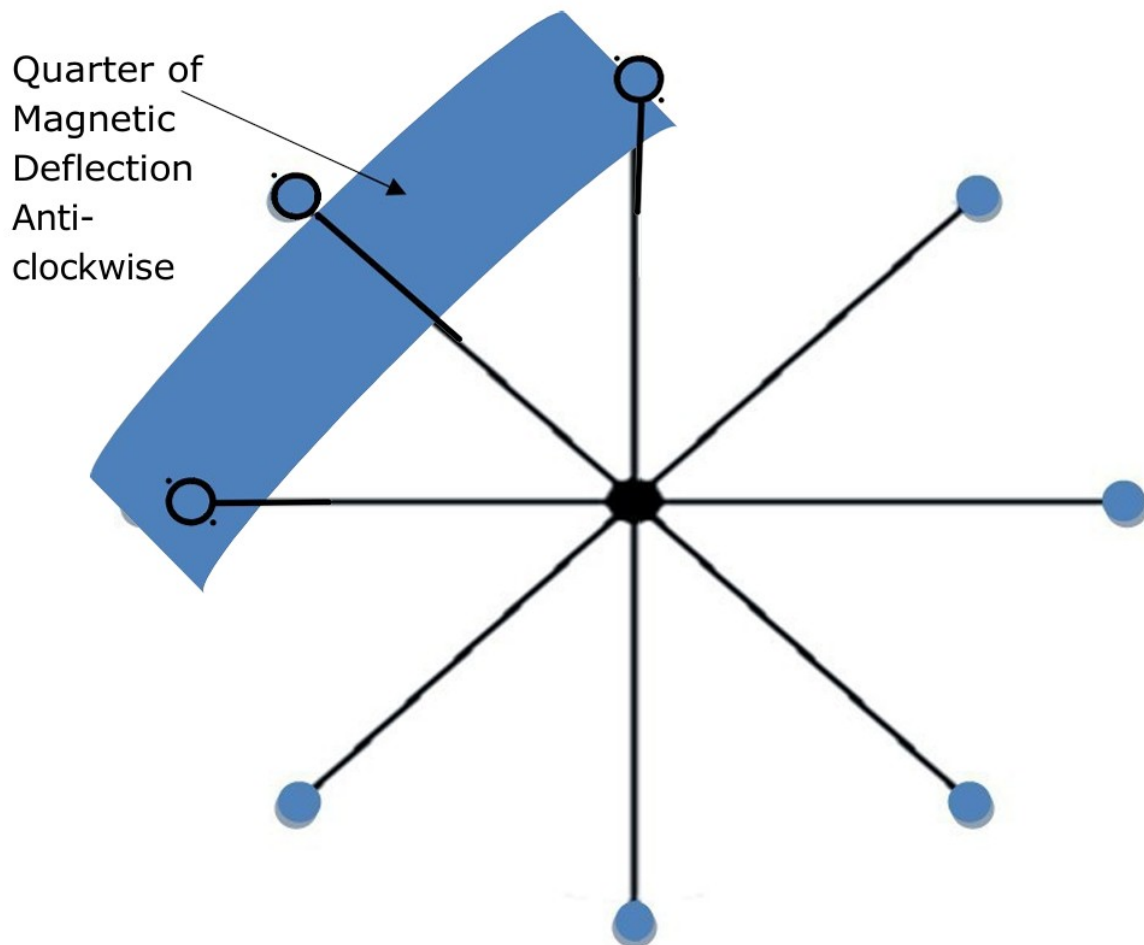

**Overview of volumetric occupancy by shuttle mass of free space:**

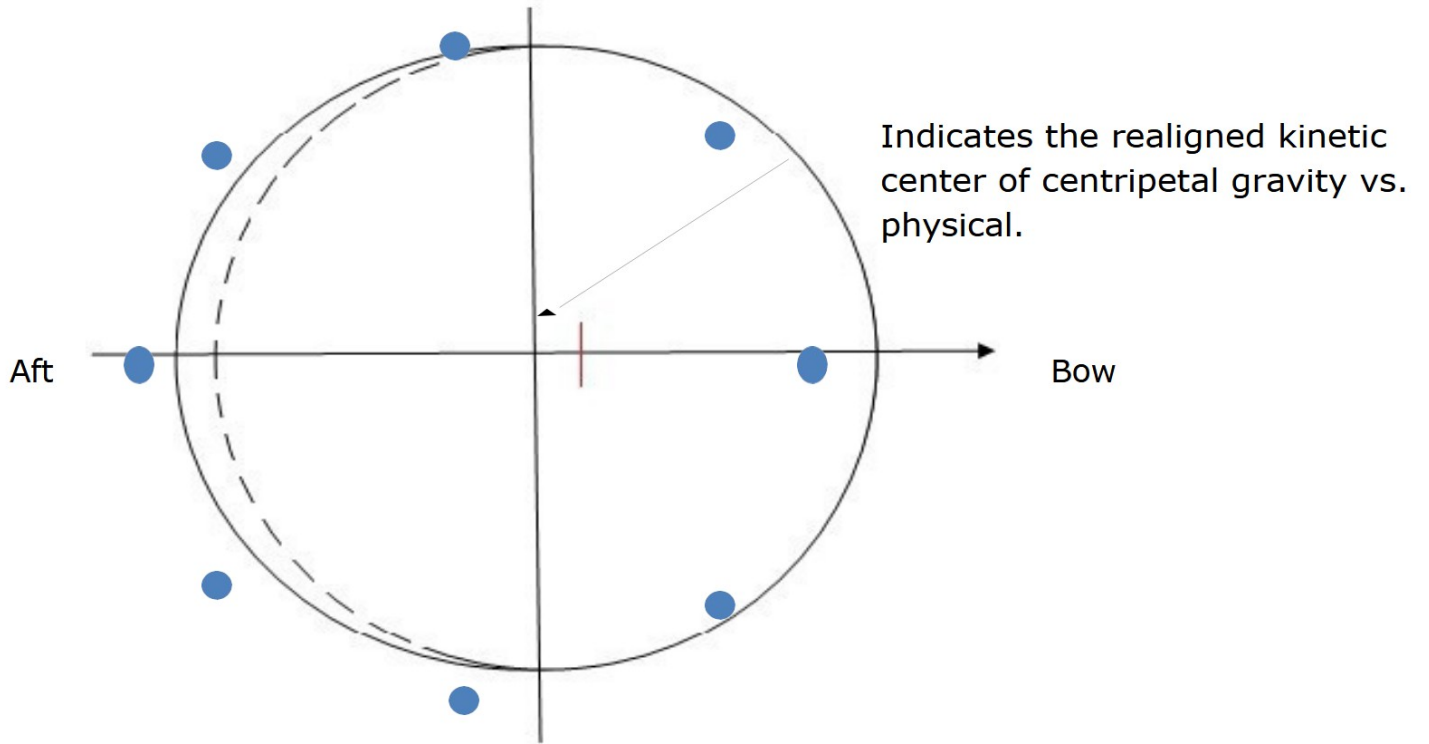

**Orbital operating disk reference frame:**

This acceleration propulsion concept Orbital disjunction above can be reasoned with the following argumentation:

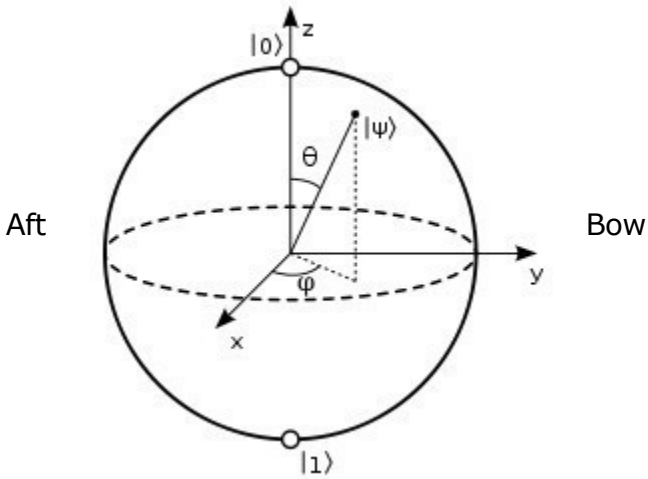

Rotation has the potential of acceleration and given torque / coreolis / centripetal and centrifugal force properties the tensile structure of structural composition will use energy to compete for and maximize space available to it at zero degrees (y). When spun into a curved space rotation at a high state of torque acceleration the disks will occupy and attempt to own the path of least resistance affording maximum space this is to say that it will occupy with great force the available space at zero degrees of spin (y) along the equatorial of the axis of the spoke disk component. We can then say that with induction application of an opposition force the electro magnets will cause a distention zone in opposition to the 180° degree spin of the axis of the disks causing it to consummate that state of acceleration to spin at off axis of equatorial positively or negatively so that the Aft side of the disk is angularly spun off axis away from equatorial where it would afford path of least resistance and where it occupies and consummates occupancy of greatest geometric space in that by owning this path it spins with the greatest afforded space by the energy it has by torque state of acceleration. Detracting from this by opposition of great magnetic force either side of the zero or 180° degrees of axis spin the device affords less space along a restricted path of spin so it can be inferred and asserted that the Aft side of spin occupies less space with angular force acting against path of least resistance when deflected when compared to the Bow side 0° of the device which is allowed to take the path of greatest geometric volume unhindered in unison at fulcrum with the Aft side. Potentially the Fore side of the device occupies greater space geometrically with greater collective force and is in fact spinning unimpeded with greater force of acceleration than the Aft side. It can be logically said that the Bow side of the rim is metrically rotating faster over distance than the Aft side so that the state of acceleration torque at the Fore side of this rim is greater than the Aft side such that the direction of drive of this device will be in the direction of the Bow of the device ( to the right ) allowing transference from null rotation momentum to magnetically disjunctured acceleration in this exhibit.

### **Attenuation of rotation mass**

The shuttle mass rotation frame of centripetal propeller can be additionally attenuated with the introduction of noise in the form of ultrasound / sonar or suitable physical resonance. The structured velocities of the shuttle mass is attenuated with introduction of resonance energy in detriment or augmentation of structured rotations in the rotation frame to compliment propulsive energy in attenuation.

## Counter balanced rotation:

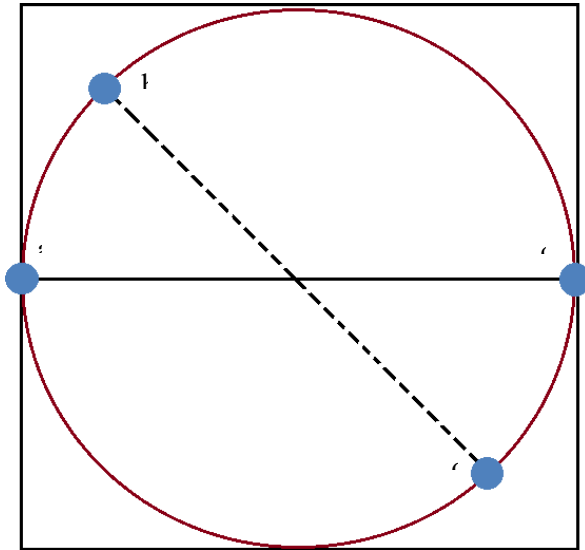

In the figure above we see a cross section illustration of rotation from a side view of the device ( a and c ) where we can compare the solid line (c) illustration as start rotating through to the dashed line as with a..b on the left side and c..d on the right side. We can make note that at a deflected angle of 45 degrees the distance travelled by the Aft side is less than the distance travelled had it been at a straight line undeflected as with the right side (Fore). The centripetal force produced by the device on the left side of the device is less than the right  $\therefore$  the radius distance of the weight ( one kilo ) on the left side is reduced.

In the figure above we see an illustration overview of rotation of the device where we can note rotation counter balanced from a..b at the left of the device and rotation from c..d on the right side of the rotation for a coupled spoke respective of fulcrum in it's middle. It takes the same time for arc rotation consuming an equal degree of rotation for  $\Leftrightarrow$  left and right side components of the device irrespective of deflection.

### Deflection overview quarter two:

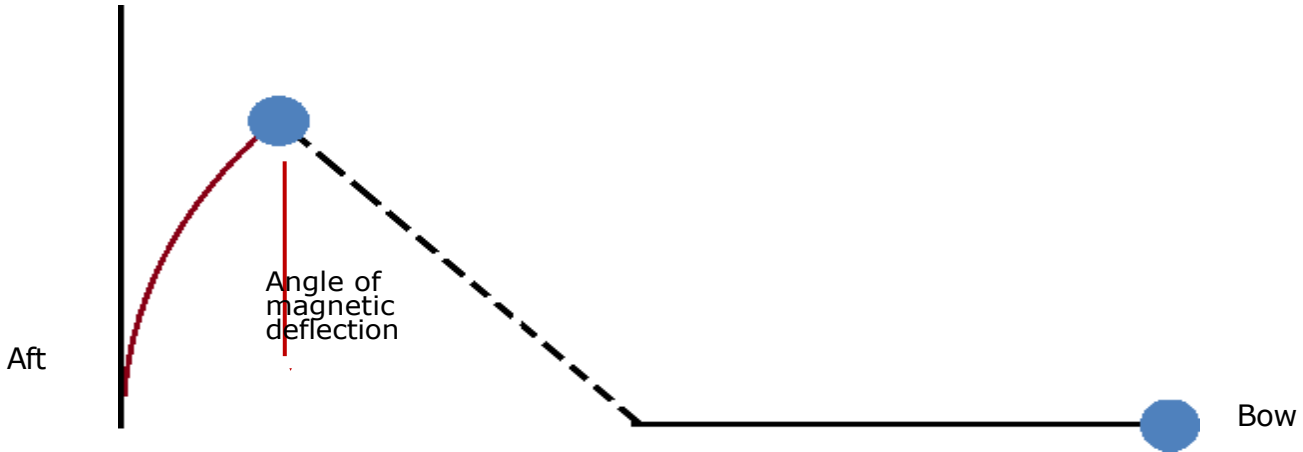

In this figure we see our angle of deflection to be on start the in seam of the shuttle mass from fulcrum perpendicular  $90^\circ$  directly below so that the force exerted is redistributed for the shuttle mass exerting a downwards force at  $90^\circ$  of spin.

### Magnetic release overview quarter three:

Angle of magnetic release with release magnet above the shuttle mass.

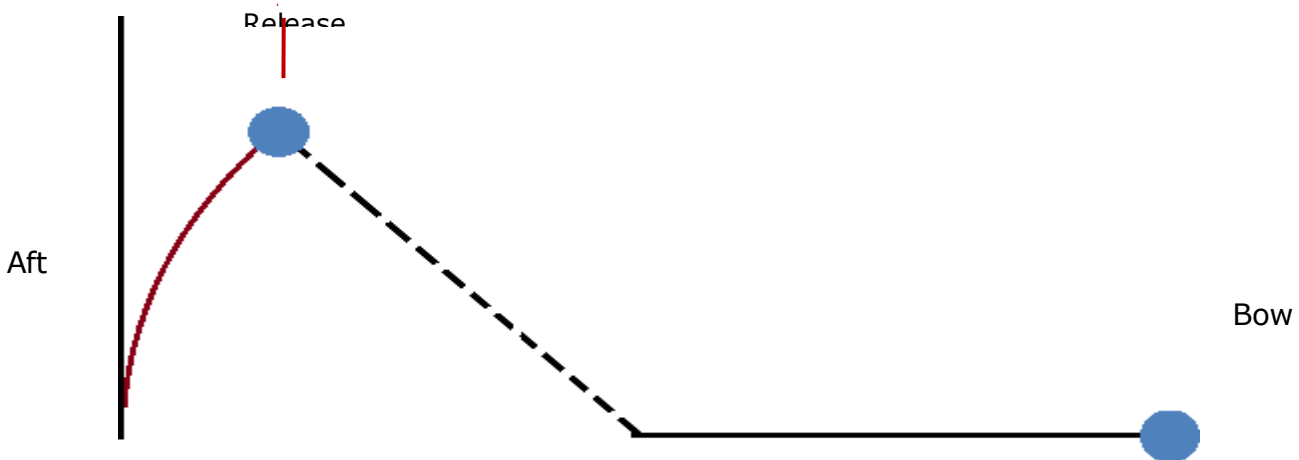

In this figure we see our angle of release to be from above the shuttle mass so that the force exerted is redistributed for the shuttle mass exerting a downwards force at 90° of spin. This highlights the different dynamic properties of magnetic release and deflection from in-seam and from above.

Configuration of vantage from below and above the shuttle mass allows for setting of the device with gate variable property 1/0, 0/1, 1/1, 0/0 to present use of  $\Leftrightarrow$  mount points placing the load of deflection / release at any point perpendicular on vertical axis to spin plane at equator and including alternation of load point. Repell / deflect is deceleration / acceleration whereas lift / attract becomes accelerate / decelerate tools with which to manipulate angular momentum. Where  $\theta$  = deflection and 1 = lift attraction we find that we can sequence either 0/1 conversely 1/0 for the upper disk shuttle which are opposing sequences with differing dynamics.

### **Post deflection quarter three**

The quarter post deflection provides thrust as with the deflected quarter and requires a controlled release from the deflected shuttle mass position. This can be accomplished for example with use of a magnetic release, shown in illustration below, as with the deflected quarter. In this case a magnetic release so that acceleration potential is buffered through the entire quarter as per overview of volumetric occupancy for optimal device results for the upper gyro disk. The lower device gyro disk is thus a clockwise (on overview) reverse sequential of the upper disk to counter torque.

Magnetic release from above shuttle mass.

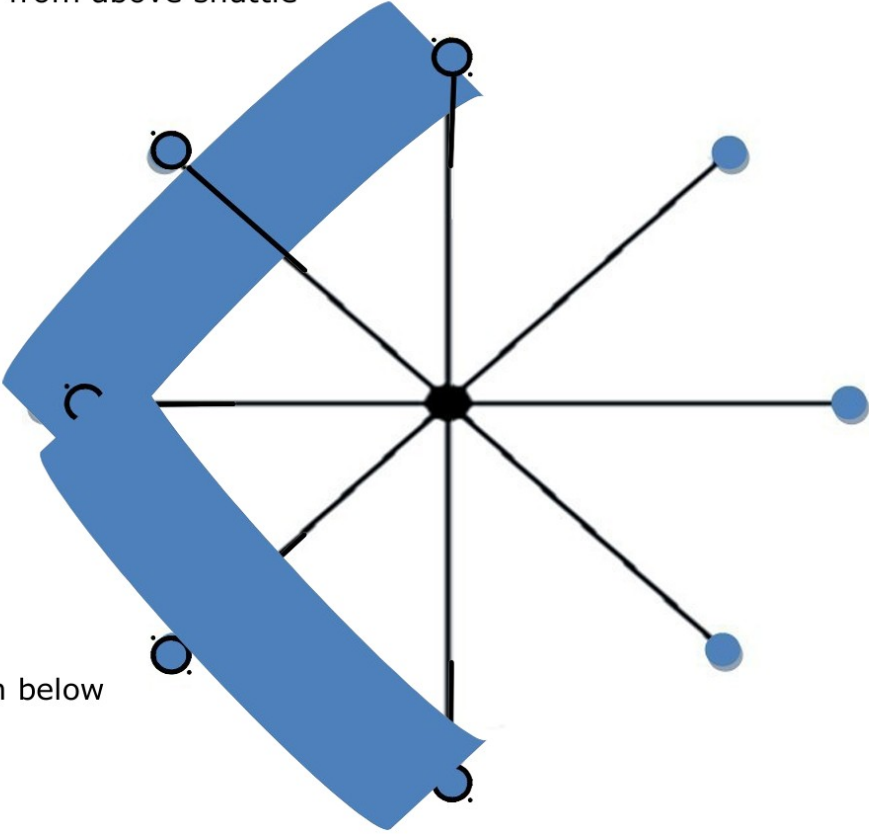

Magnetic lift from below shuttle mass.

**Momentum bias generation :**

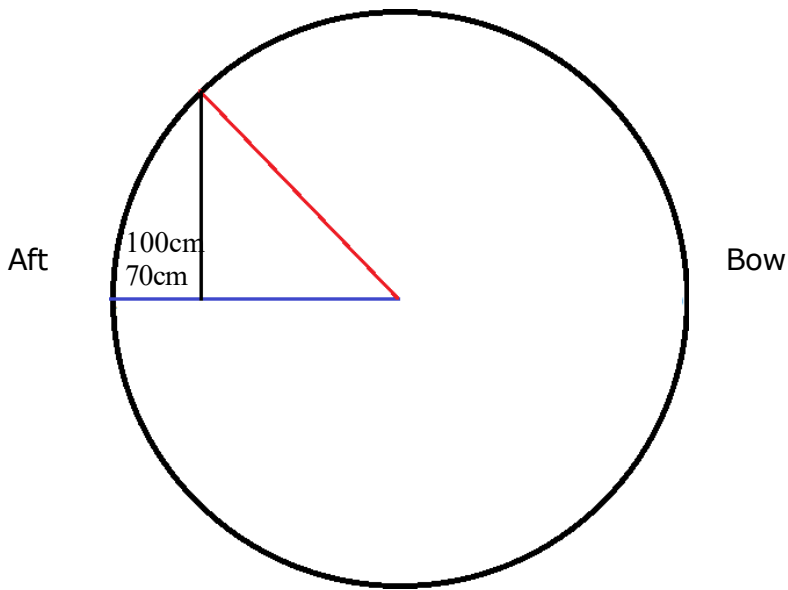

We can see in this illustration of a two meter drive above that upon deflection the radius for calculating centripetal acceleration having rotated from a..b (Aft) becomes a radius of 70cm versus 100cm using a two meter drive template.

Should one then have a two meter drive with radius of one meter where the angular to linear velocity formula is :  $\mathbf{v = r \times \omega}$  results in a linear velocity of **7.3304m/s** for 70cm deflected at 100 rpm. This is a difference from the Bow side's counterbalance of the same weight at 100cm unhindered resulting in a velocity of **10.472m/s** a difference of **3,1416m/s**.<sup>54</sup>

$\mathbf{f = mv^2 / r}$  is the formula for centripetal acceleration and results in **76.7639488** centripetal force for the 70cm (Aft) side counterbalanced by **109.66278399** of centripetal

force (Bow) side spinning at 100rpm. This is a propulsive difference resulting **32.8988** of thrust produced by the device's component of two counter opposing spokes.<sup>55</sup> spanning two meters having a radius of one meter and a one kilo weight at the end of each spoke

55

---

<http://calculator.tutorvista.com/physics/533/centripetal-force-calculator.html>

### **Recursive argument:**

A one kilogram weight at the end of a disc spoke on the Aft side of the disc when deflected at a vertical 45 degree angle from equatorial travels a shorter orbital distance at a lower speed in it's hemisphere than a opposing matching weight on the Fore side of the disks occupying less volumetric space; this results in disjunction where the centripetal force produced by the weight at the deflected Aft side is less than it's counter weight on the Bow side of the device and is distended. The Aft side of the device rotates at a slower speed than the Bow side in sum total producing acceleration of the rim in the direction of the Fore side of the device. This lesser distance as stated is respective of the X / Y axis depicted in the diagram which results in and is proportional of the centripetal force produced along this plane determining the net resulting force to produce acceleration.

Note: In our exhibit here we use a two meter device employing 40 kilograms of shuttle mass and we use magnetics to deflect the shuttle mass.

### **Requirement:**

This is a unique breakthrough of process and methodology as well as state of acceleration component potential for aerospace logistics propulsion complementary. The technologies employed exist where the practice, usage and conception did not; I claim ownership as proponent and originator of this concept step towards propulsion methodology having researched and developed this solution. This type of acceleration device does not exist and I am the originator of this concept which is in part theoretical and unproven. This device is available and justified in what can be called a demonstration of anomaly in the laws of Newtonian motion.

Stefan Y. A. Tubman